

ACCESSORIES
CATALOGUE

SEASON 2019



KELLYS
BIKE COMPANY





RIDER

- 010 CYCLING CLOTHING
- 027 PROTECTIVE GEAR
- 028 CASUAL CLOTHING
- 034 GLOVES
- 042 EYEWEAR
- 048 HELMETS
- 060 BACKPACKS

BICYCLE

- 070 LIGHTS
- 080 REFLECTIVE ACCESSORIES
- 081 CYCLE COMPUTERS
- 082 BOTTLES
- 086 BOTTLE CAGES
- 088 PUMPS
- 094 LOCKS
- 100 BAGS
- 108 BASKETS
- 111 CARRIERS
- 112 MUDGUARDS
- 116 KICKSTANDS
- 117 CHAINSTAY PROTECTORS
- 118 BELLS
- 119 MIRRORS
- 120 SADDLES
- 126 HANDLEBARS, STEMS, SEATPOSTS
- 130 GRIPS
- 133 BAR ENDS, HANDLEBAR TAPES
- 134 PEDALS

SERVICE & CARE

- 140 TOOLS
- 144 CLEANERS, LUBRICANTS
- 148 BRAKE ACCESSORIES
- 152 TUBE REPAIR KITS / TUBES
- 153 TYRES
- 154 CHAINS
- 155 INNER WIRE - OUTER CHASING / RIM TAPES
- 156 RIMS
- 158 WHEELS
- 159 BB CARTRIDGES / HEADSETS



**EVERY BIKE
HAS A MISSION**



INTRO



KELLYS AND KLS BICYCLE CLOTHING AND GEAR, SMART ACCESSORIES AND HIGH-QUALITY PARTS ARE DESIGNED BY BIKERS FOR BIKERS, TO BRING MORE JOY, SAFETY AND STYLE TO EVERY RIDE. IT DOES NOT REALLY MATTER IF YOU ARE A MOUNTAIN BIKER, ROAD RACER, URBAN COMMUTER OR RECREATIONAL RIDER. YOU ALWAYS DESERVE THE BEST RIDING EXPERIENCE, AND OUR MISSION IS TO MAKE IT POSSIBLE.



RESEARCH & DEVELOPMENT

DEPARTMENT

CREATION OF A REAL BIKER'S PRODUCT IS A PROCESS WHERE THE LATEST ENGINEERING KNOWLEDGE, THE BEST MATERIALS AND TRUE CYCLING PASSION ARE NEEDED TO BE ENCLOSED IN A USEFUL BUT ALSO BEAUTIFUL FORM. HOWEVER, WE BELIEVE THAT IT IS NOT ENOUGH...





Kellys Research and Development team is a group of people who are not only ingenious engineers and inventors but also active riders, who knows the bikers needs and demands the best. When creating the new products, they always add the unique particle of Every Bike Has a Mission philosophy, which is why every new idea starts with the sense of a mission which needs to be fulfilled. We believe that this is the only way to add something special to every ride, something which cannot be measured, tested or described. This is something which every biker can feel only when using Kellys products.



This is the reason why we are proud of all Kellys bicycle accessories and parts, cycling clothes and gear, carrying the unique particle of Kellys' **EVERY BIKE HAS A MISSION** philosophy.



ACCESSORIES

RIDER





ROAD

ESSENTIALS





1 RIVAL long sleeve jersey 2 RIVAL bibshort 3 RIVAL gloves 4 DICE sunglasses 5 SCORE helmet 6 JET 8 backpack 7 RIVAL socks



Smart reflective prints to keep you visible during the dark

Stand up collar to shade your neck during the sunny days

Back pockets with one 1 zipper pocket for easy on-to-go access



Short raglan sleeves for higher comfort



RIVAL blue



RIVAL black

Light breathable fabric with mesh inserts

Full length zipper and mesh back part increase body ventilation

Longer back part for coverage when riding



Soft silicon gripper

RIVAL JERSEY SHORT SLEEVE

Premium short sleeve jersey with full length zipper is developed in ergonomic fit that adapts to your needs as a road or cross-country rider. Jersey combines a light breathable fabric with mesh inserts for maximum ventilation and moisture control. Thanks to 3 back pockets including one zip pocket you will have room to bring all your gear and nutrition boosts you need during your ride. Rival jersey with elegant graphic and distinctive racing style with smart reflective prints will keep you pedalling for hours, even in the dark.

COLORS: black, blue
SIZES: S, M, L, XL, XXL

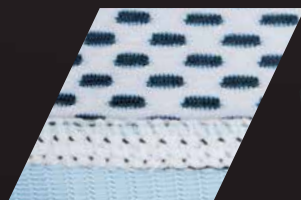

Flat seams



3 back pockets with reflective printing



Silicon gripper



Mesh fabric with reflective printing

RIVAL

BIBSHORT

Premium Rival bibshorts in elegant and sleek design are made of durable and breathable fabric, added by mesh ventilation. Multi-panel bibshorts in ergonomic fit with an anti-slip elastic leg gripper hold bibshorts in the right position. Antibacterial multi-level padding and smart reflective printing provide you with the best comfort and visibility and will keep you pedalling the longest ride even during the night.

COLORS: black, blue

SIZES: S, M, L, XL, XXL



RIVAL
blue

RIVAL
black



Soft silicon gripper

Smart reflective prints
to keep you visible
during the dark

Antibacterial
multi-level padding

Multipanel ergonomic fit



RIVAL
blue

RIVAL
black

RIVAL

JERSEY LONG SLEEVE

Premium long sleeve jersey with full length zipper provides the extra protection you need when the weather gets colder. With the same great features as the short sleeve Rival jersey, including the 3 back pocket and reflective printing you won't be missing anything while riding during the colder days. Thanks to structured technical fabric that allows moisture transportation you will stay warm and dry during the whole ride.

COLORS: black, blue

SIZES: S, M, L, XL, XXL







TRAIL

ESSENTIALS

1 TYRION long sleeve jersey. 2 RIDER short. 3 RAVE helmet. 4 DICE sunglasses. 5 TYRION gloves. 6 SWITCH 18 backpack. 7 RIDER socks.

RIDER / CYCLING CLOTHING



TYRION

ENDURO JERSEY LONG SLEEVE

Durable, airy and stylish enduro jersey with a comfortable cut, raglan long sleeves and elongated back intended for mountain biking. Fast drying polyester fabric and airy back part allow the rider to stay dry and comfy with distinctive enduro style. On top of that, it comes with special microfiber glasses/goggles cleaning patch.

COLORS: blue, beige
SIZES: S, M, L, XL, XXL



TYRION
blue



TYRION
beige



TYRION

ENDURO JERSEY SHORT SLEEVE

Durable, airy and stylish enduro jersey with a comfortable cut, raglan short sleeves and elongated back intended for mountain biking. Fast drying polyester fabric and airy back part allow the rider to stay dry and comfy with distinctive enduro style. On top of that, it comes with special microfiber glasses/goggles cleaning patch.

COLORS: blue, beige
SIZES: S, M, L, XL, XXL



TYRION
blue



TYRION
beige



RIDER

LOOSE FIT SHORTS

Universal MTB shorts with light but durable outer material Taslan for comfort and wide range of movement. Detachable inner lycra shorts with antibacterial padding. With reflective logos for your safety.

SIZES: S, M, L, XL, XXL



WOMENS

ESSENTIALS





1 **MADDIE** jersey 2 **MADDIE** tights short 3 **WRAITH** photochromatic sunglasses 4 **MADDIE** gloves 5 **SCORE** helmet 6 **LANE 16** backpack 7 **FTT** socks

RIDER / CYCLING CLOTHING



MADDIE

WOMEN JERSEY

With full length zipper and breathable fabric, Maddie jersey provides optimal heat and moisture management. Soft and lightweight fabric is fast drying and provides the comfort even during the longer rides. Thanks to 3 back pockets you will have room to bring all your gear and nutrition boosts you need. Maddie jersey with Kellys original design and reflective prints will keep you riding, even when it gets dark.

COLORS: blue, pink

SIZES: S, M, L, XL

MADDIE

TIGHTS SHORT

Maddie multi-panel tights designed for women are made of durable and breathable fabric, added by mesh ventilation for optimal heat and moisture management. Anti-slip elastic leg grippers hold tights in the right position. Antibacterial multi-level padding and reflective printing provide you with the best comfort and visibility during the rides even in the dark.

COLORS: blue, pink

SIZES: S, M, L, XL, XXL





MADDIE

TIGHTS ¾

Maddie multi-panel tights designed for women are made of durable and breathable fabric, added by mesh ventilation for optimal heat and moisture management. Anti-slip elastic leg grippers hold tights in the right position. Antibacterial multi-level padding and reflective printing provide you with the best comfort and visibility during the rides even in the dark.

COLORS: blue, pink

SIZES: S, M, L, XL, XXL



LARA

LOOSE SHORTS

Universal loose cycling shorts made of light but durable outer material for comfort and wide range of movement. Detachable inner lycra shorts with antibacterial anatomically shaped multi-level padding. With reflective printing for your safety.

SIZES: S, M, L, XL, XXL

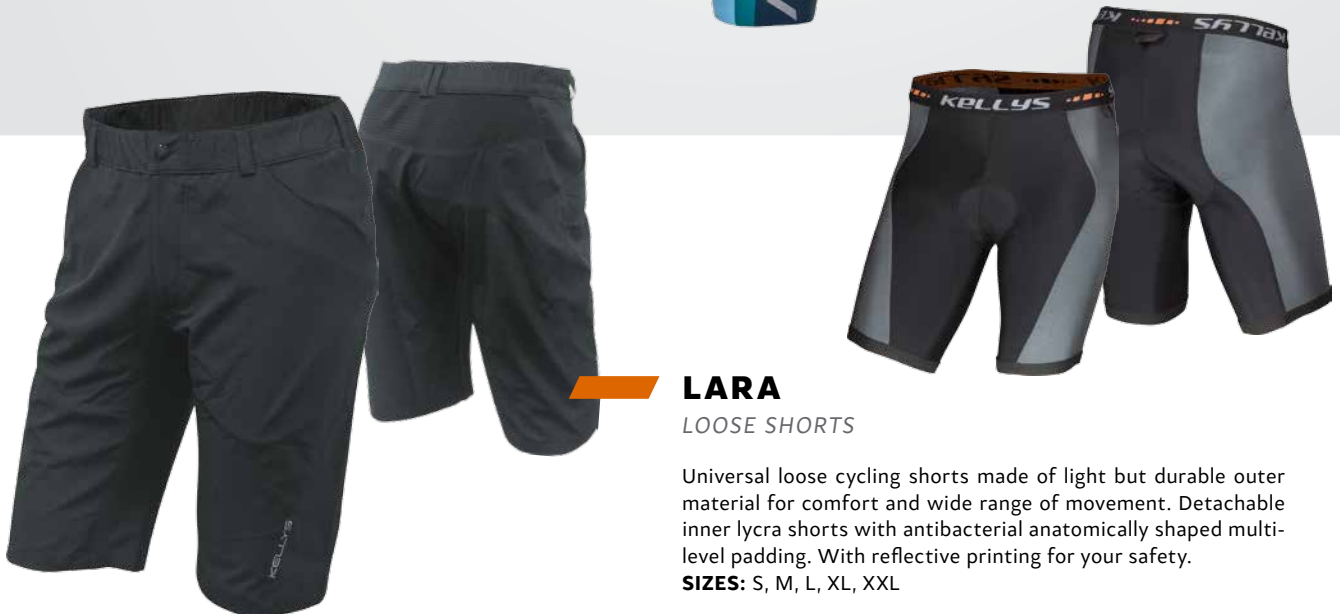



RIVAL

WINDPROOF JACKET

Kellys Rival jacket will be your top choice to compete against the wind and the rainy weather. Bright color of the membrane jacket fabric will make you visible on the road even from the distance. This jacket is made of the ITTAI® windproof and water repellent material with excellent breathability. On the top of this the jacket has back opening which keeps you ventilated during the ride. Thanks to the 3 back pockets you will have room to bring all belongings you need with you and you'll stay visible even in the dark with the reflective printing.

SIZES: S, M, L, XL, XXL





PRO SPORT WIND

JACKET

PRO RACE ISOWIND jacket is made from combination of wind blocker membrane and breathable fabrics. This combination offers you wind protection with optimal breathability. The jacket has full length zipper which allows you to control your body temperature easily and high collar which keeps the wind and moisture off the neck. Jacket is made in simpler look for more leisure rides and it's added by the reflective printing for better visibility during the rides in the dark.

SIZES: S, M, L, XL, XXL



WIND PACK

JACKET

Ultralight and windproof jacket made of micro-polyamid fibres with rip-stop treatment (against tearing). You can stuff this jacket into its own pocket to put into your back pack or even into your jersey back pocket. So the jacket is allways available when the weather turns nasty or for a chilly downhill. There is plenty ventilation thanks to mesh on the back and in the arm pits for higher breathability. With reflective Kellys logo for your safety.

COLORS: black, green

SIZES: S, M, L, XL, XXL

WINDPACK
green

WINDPACK
black



ARM WARMERS THERMO

Made of functional and elastic thermo fabric with great thermal performance to protect against cold. Their are highly breathable and transports moisture to the outside. With an anti-slip gripper at the upper part to hold warmers in the right position and smart reflective printing for your safety.

SIZES: S, M, L, XL, XXL



KNEE WARMERS THERMO

Made of functional and elastic thermo fabric with great thermal performance to protect against cold. Their are highly breathable and transports moisture to the outside. With an anti-slip gripper at the upper part to hold warmers in the right position and smart reflective printing for your safety.

SIZES: S, M, L, XL, XXL



THERMO RBX

BIBTIGHTS

Made of the SuperRoubaix® super-stretch thermo fabric. These special multi-panel bibtights provides you with a comfortable fit. With or without a breathable and antibacterial Hygienic® multilevel padding. Reflective printing at the back panel for your safety.

SIZES: S, M, L, XL, XXL



LEG WARMERS THERMO

Made of functional and elastic thermo fabric with great thermal performance to protect against cold. Their are highly breathable and transports moisture to the outside. With an anti-slip gripper at the upper part to hold warmers in the right position and smart reflective printing for your safety.

SIZES: S, M, L, XL, XXL

THERMO RBX
bibtights with/without padding



THERMO ISOWIND
bibtights with/without padding

COOLMAX®

wicks sweat away from body keeps you cool, dry and comfortable, lightweight, soft and breathable, DuPont performance tested and certified

SUPERROUBAIX®

fast-recovery super-stretch fabric air permeable, strong, soft comfortable and easy care

ISOWIND®

functional fabric with a comfort and easy-care properties:

- waterproof, windproof, water vapor permeable
- 4 way stretch
- keeps its shape

THERMO ISOWIND

BIBTIGHTS

The front part is made of the Isowind® windproof fabrics and the rear part from SuperRoubaix® super-stretch thermo fabric for colder and windy days. With or without a breathable and anti-bacterial Hygienic® multilevel padding. Reflective printing for your safety.

SIZES: S, M, L, XL, XXL



CAP WINDBLOCKER

It is designed to be worn under helmet. Made from a combination of different panels for optimal protection and moisture regulation. With Kellys reflective logo for your safety. One size fits all.



SHOE COVERS WINDBLOCKER

Made of WINDBLOCKER windproof fabric to keep your feet warm. The covers have a full length zipper at the back for comfortable fit with a reflective velcro strap and reflective printing for your safety.

SIZES: S/37-38, M/39-40, L/41-42, XL/43-44, XXL/45-46



RIDER
SOCKS

Flexible and comfortable Kellys Rider socks with a higher profile are made to fit and provide comfort even during the longer rides. Anatomically shaped with a special elastic strap ensure secure fit. The socks have a reinforced heel and a tip for durability in stressed areas.

COLORS: blue, beige
SIZES: 39 - 42, 43 - 46



RIVAL
ROAD AND XC SOCKS

In original Kellys design. Made from quality Coolmax fibers for great breathability and durability. Anatomically shaped socks for left and right foot. With a special elastic strap for perfect, stable and comfortable fit.

COLORS: black, blue
SIZES: 39 - 42, 43 - 46

FIT
SOCKS

Invisible socks made of cotton for great comfort. Anatomically shaped socks have a special elastic strap for perfect, stable and comfortable fit. Also for every day wear.

COLORS: black, white
SIZES: 38 - 42, 43 - 47



labyrinth lime



ride your life black



MULTI-FUNCTIONAL SCARF

Possible to wear around neck, like a cap, on wrist or whatever you like
100% polyester

COLORS: paisley orange, logo black, ride your life black, illusion yellow, labyrinth lime, tetris blue

logo black



paisley orange



illusion yellow



tetris blue

KITER PADS

YOUTH PROTECTION PADS

Protective elbow and Knee pads
Contains 2 elbows and 2 knee pads
2 tone, PP shell and foam Pad,
Adjustable Polyester Velcro
POM Buckle





MISSION:

— THE STYLE EXPERT





KELLYS MOUNTAINS

MEN'S T-SHIRT

Body & BNT - 160 GSM Single Jersey
100% Cotton
semi - combed ring-spun cotton,
single jersey
neck strap, spandex rib collar
SIZES: S, M, L, XL, XXL

KELLYS MOUNTAINS

WOMEN'S T-SHIRT

Body & BNT - 160 GSM Single Jersey
100% Cotton
semi - combed ring-spun cotton,
single jersey
neck strap, spandex rib collar
SIZES: S, M, L, XL, XXL



BIKER
melange



BIKER
red

BIKER

WOMENS' T-SHIRT

Body & BNT - 160 GSM Single Jersey
60% Polyester, 37% Cotton, 3% Elastane - Knitted
Rib - 1x1 97% Cotton, 3% Elastane - Knitted
Wash - Softener Bio Wash that provides longevity
and smooth hand-feel
SIZES: XS, S, M, L, XL
COLORS: melange, red



BIKE MISSION
grey

BIKE MISSION
blue

BIKE MISSION
WOMENS' T-SHIRT

Body & BNT - 160 GSM Single Jersey
60% Polyester, 37% Cotton, 3% Elastane - Knitted
Rib - 1x1 97% Cotton, 3% Elastane - Knitted
Wash - Softener Bio Wash that provides
longevity and smooth hand-feel
SIZES: XS, S, M, L, XL
COLORS: blue, grey



MELANGE
purple (women)



BASIC
teal (women)

BASIC HOODIE
HOODIE

Body - 340 GSM Brushback Fleece
60% Cotton, 40% Polyester
Rib - 2x2 Rib 97% Cotton 3% Elastane
Hood & Pocket Lining - 160 GSM Single Jersey
100% Cotton
Wash - Softener Bio Wash that provides
longevity and smooth hand-feel

MELANGE HOODIE

HOODIE

Body - 340 GSM Brushback Fleece 60%
Cotton, 40% Polyester
Rib - 2x2 Rib 97% Cotton 3% Elastane
Hood & Pocket Lining - 160 GSM Single
Jersey 100% Cotton
Wash - Softener Bio Wash that provides
longevity and smooth hand-feel





KELLYS ORIGINAL

CAP

87% Acrylic / 11% Wool / 2% Spandex
Stylish Poly Suede Visor
Contrast Visor and Top button
COLORS: grey, blue



SIGN

CAP

Original FLEXFIT® cap with flat visor
Comfortable feel
92% acrylic, 15% wool 2% spandex
SIZES: S/M, L/XL



NO RULES

CAP

47% Cotton / 25% Polyester / 28% Nylon
5 Panels
Flat Visor
SIZES: OSFA

RIDE YOUR LIFE

CAP

83% Acrylic / 15% Wool / 2% Spandex
6 Panels
Contrast Visor and Top Button
SIZES: S/M, L/XL





KELLYS

BEANIE

100% dry Acrylic knitted beanie with 100% Polyester micro fleece and Pom-pom, woven label.



MELANGE PRIMALOFT

BEANIE

100% Acrylic knitted beanie with waterproof Pirmaloft insert lining



3 STRIPES

BEANIE

100% Acrylic with Pompom, Insert lining: Thinsulate 3M C40



MULTISTripES

BEANIE

100% Acrylic knitted beanie with woven label





— GLOVES

TYRION



TYRION

LIGHTWEIGHT
ENDURO GLOVES

TYRION

GLOVES

- Lightweight and durable gloves with no padding
- Comfortable neoprene wrist closure
- Perforated synthetic leather on the palm
- Touch screen friendly silicone fingertips
- Silicone palm area for better grip
- Reinforced thumb area

COLORS: blue, beige
SIZES: XS, S, M, L, XL, XXL



TYRION
blue

TYRION
beige

BOND

GLOVES

Lightweight and well ventilated super thin gloves with no padding

Cuffless wrist closure

AX Suide Cinco synthetic leather on the palm

Touch screen friendly silicone fingertips

Silicone palm area for better grip

Reinforced thumb area

COLORS: blue, lime

SIZES: XS, S, M, L, XL, XXL



RELIC LONG

GLOVES

Lightweight glove with no padding

Single layer perforated CLARINO synthetic leather on the palm

Silicone fingertips for better grip

Reinforced thumb area

Neoprene wrist tab closure

COLORS: grey, lime, orange

SIZES: XS, S, M, L, XL, XXL





HYPNO LONG

GLOVES

Durable and lightweight glove with thin gelfoam padding
 Two-way padding system on the palm
 Double layer CLARINO synthetic leather on the palm
 Silicone fingertips for better grip
 Thumb area with micro-suede towel
 Wrist tab closure
COLORS: grey, lime, blue
SIZES: XS, S, M, L, XL, XXL



FLOW LONG

GLOVES

Durable and lightweight glove with gelfoam padding
 Ergonomic padding on the palm
 AX Suede Deuce synthetic leather on the palm
 Silicone fingertips for better grip
 Thumb area with micro-suede towel
 Wrist tab closure
COLORS: grey, lime, blue
SIZES: XS, S, M, L, XL, XXL



HYPNO SHORT

GLOVES

Durable and lightweight glove with thin gelfoam padding
Two-way padding system on the palm
Double layer CLARINO synthetic leather on the palm
Thumb area with micro-suede towel
Wrist tab closure

COLORS: grey, lime, blue
SIZES: XS, S, M, L, XL, XXL



FLOW SHORT

GLOVES

Durable and lightweight glove with gelfoam padding
Ergonomic padding on the palm
AX Suede Deuce synthetic leather on the palm
Thumb area with micro-suede towel
Wrist tab closure

COLORS: grey, lime, blue
SIZES: XS, S, M, L, XL, XXL



RIVAL

GLOVES

Lightweight lycra gloves with foam padding
Two-way padding system on the palm
Thumb area with micro-suede towel
Cuffless wrist closure

COLORS: black, blue
SIZES: XS, S, M, L, XL, XXL





MADDIE

WOMEN GLOVES

Lightweight lycra gloves with foam padding
Two-way padding system on the palm
Thumb area with micro-suede towel
Cuffless wrist closure

COLORS: blue, pink

SIZES: S, M, L



COMFORT

GLOVES

Durable and lightweight glove with thin gelfoam padding
Two-way padding system on the palm
Thumb area with micro-suede towel
Wrist tab closure

COLORS: grey, lime, blue, red

SIZES: XS, S, M, L, XL XXL

COLDBREAKER

GLOVES

Winter gloves with pre-curved fit
Breathable and windproof construction
Touch screen friendly silicone fingertips
Silicone reinforcement of palm and fingers for a better grip
3M reflective trim and printing
Rubber wristband closure.
Thumb area with high absorbing micro-suede towel

COLOR: black

SIZES: S, M, L, XL, XXL



FROSTY

GLOVES

Winter gloves for cold and frosty weather
Made of membrane HYPORA Winbreaker material
Silicone reinforcement of palm and partially fingers for a better grip
Double stitched palm for durability
Wristband for a better protection.

COLORS: black, blue, red, grey

SIZES: S, M, L, XL, XXL (black only)



NYX

YOUTH GLOVES

Gloves for kids
Velcro wrist closure
Padded palm area
COLORS: lime, red, pink
SIZES: small, large

GOUKI

YOUTH GLOVES

Gloves for kids with pre-curved fit
Wide opening Velcro wrist closure
Silicone palm area for better grip
Thumb area with absorbing towel
Comfortable neoprene wrist closure
COLOR: blue-lime
SIZES: small, large



EYEWEAR



DICE





Lightweight two-piece Grilamid TR90 frame for easy lens swapping and comfort

Anti-fog, anti-water and anti-scratch lens coating for best visibility and durability

Angular design for clear wide-angle vision

Soft rubber nose pieces and arm ends for secure fit

Single-piece swappable photochromic lens with extra clear lens

100% UVA, UVB and UVC protection up to 400nm

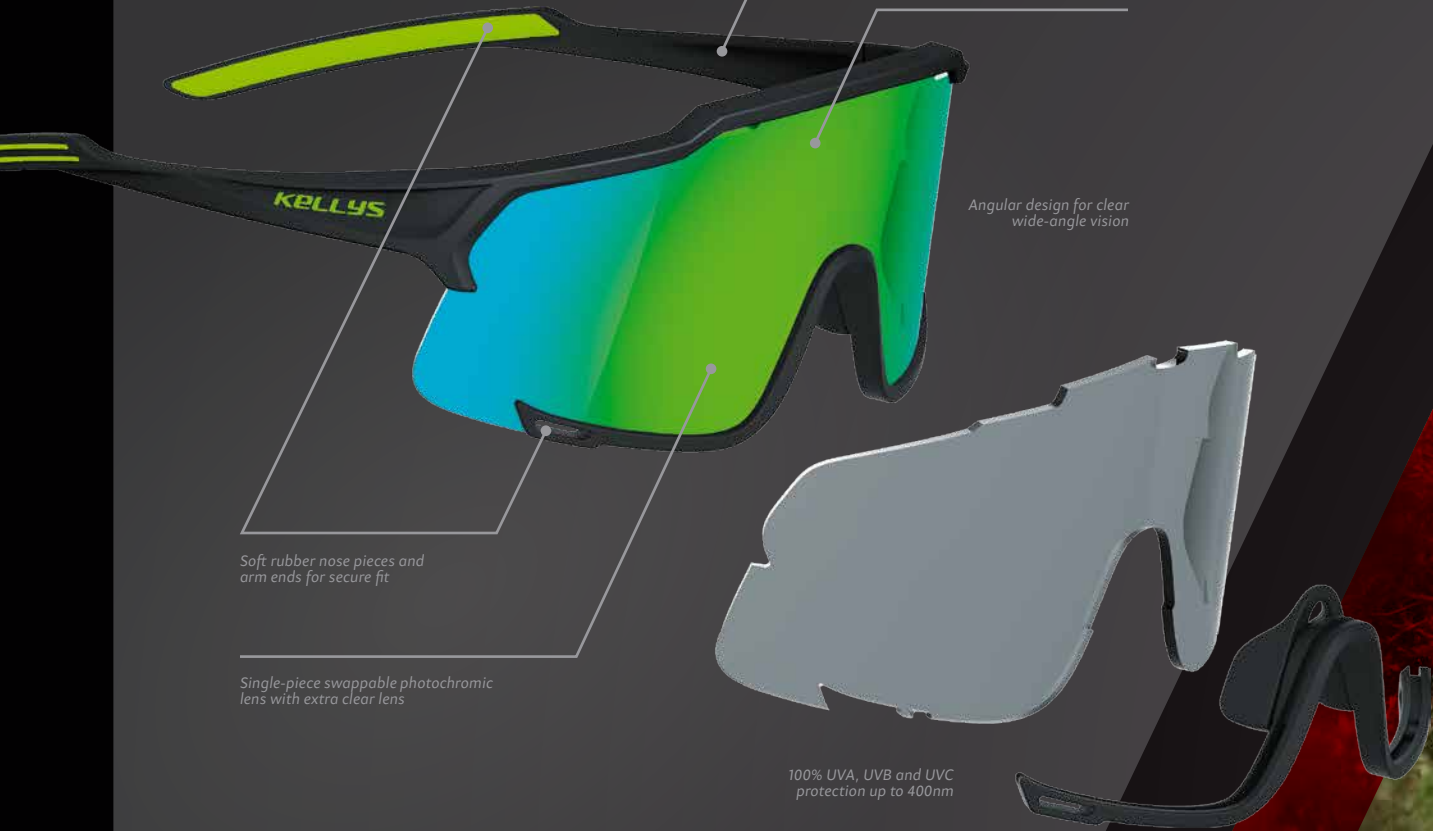

KELLYS DICE - LIGHTWEIGHT HIGH-PERFORMANCE CYCLING EYEWEAR WITH CRYSTAL-CLEAR OPTICS AND SWAPPABLE PHOTOCROMIC LENSES.

Thanks to angular design along with UV filters, anti-water and anti-fog coating, Kellys Dice glasses endure distinctive wide-angle vision under all weather condition. For high durability the anti-scratch coating to the lenses was added. Lightweight and comfortable two-piece frame made of Grilamid TR90 makes swapping lens a breeze and ensures high durability.



DICE

DICE PHOTOCHROMIC

SUNGLASSES

- 100% UVA, UVB and UVC protection up to 400nm
- Two piece superlight frame made of Grilamid TR90
- Single piece Polycarbonate lenses for clear vision
- One lens with PHOTOCHROMIC filter, other one with REVO filter
- Antiwater lens coating
- Antiscratch lens coating
- Antifog lens coating
- Cut-out lenses adjust airflow
- Comfortable nosepads
- Injected rubber ends
- Meet EN standard EN 12312:2013

- COLORS:** Shiny Black Monochrome (Photochromic lens/Blue Revo Polarized lens)
 Shiny Black-Lime (Photochromic lens/Green Revo lens)
 Shiny White (Photochromic lens/Fire Revo lens)
 Shiny Red (Photochromic lens/Grey Revo lens)





FORCE

SUNGLASSES

100% UVA, UVB and UVC protection up to 400nm
 Lightweight frame made of Grilamid TR90
 Interchangeable polycarbonate lenses
 Antiwater lens coating
 Antiscratch lens coating
 Antifog lens coating
 Cut-out lenses adjust airflow
 Comfortable and adjustable nose pads
 Injected rubber ends
 Meet EN standard EN 12312:2013

COLORS: Shiny Red (smoke/transparent)
 Shiny Black (mint/orange)
 Shiny Black PHOTOCHROMIC
 White Gloss (violet REVO/smoked)
 Shiny Lime (smoke green REVO/yellow)

FORCE
 shiny black
 PHOTOCHROMATIC



FORCE
 white gloss



FORCE
 shiny lime



FORCE
 shiny black



FORCE
 shiny red



WRAITH
 crystal ash



WRAITH
 shiny white



WRAITH
 sky blue



WRAITH
 shiny black
 PHOTOCHROMATIC



WRAITH
 shiny lime



WRAITH

SUNGLASSES

100% UVA, UVB and UVC protection up to 400nm
 Lightweight frame made of Grilamid TR90
 Interchangeable polycarbonate lenses
 Antiwater lens coating
 Antiscratch lens coating
 Antifog lens coating
 Comfortable and adjustable nose pads
 Changeable rubber ends
 Meet EN standard EN 12312:2013

COLORS: Black (mint/orange)
 Crystal Ash (mint/orange)
 Shiny White (smoke flash mirror/yellow)
 Shiny Lime (smoke green REVO/orange)
 Shiny Black (PHOTOCHROMIC smoke)
 Shiny Orange (orange REVO/blue)
 Sky Blue (Blue REVO/orange)



RESPECT
shiny white

RESPECT

LIFESTYLE SUNGLASSES

- 100% UVA, UVB and UVC protection up to 400nm
- POLARIZED polycarbonate lenses with REVO coating
- Lightweight frame made of Grilamid TR90 polycarbonate
- Comfortable fit
- Antiwater lens coating
- Antiscratch lens coating
- Antifog lens coating
- Meet EN standard EN 12312:2013

- COLORS:** Shiny Black (POLARIZED smoke flash mirror)
 Shiny White (POLARIZED green REVO)
 Crystal Ash (POLARIZED blue REVO)
 Crystal Blue (POLARIZED green REVO)
 Space Black (POLARIZED blue REVO)



RESPECT
space black



RESPECT
crystal blue



RESPECT
shiny black

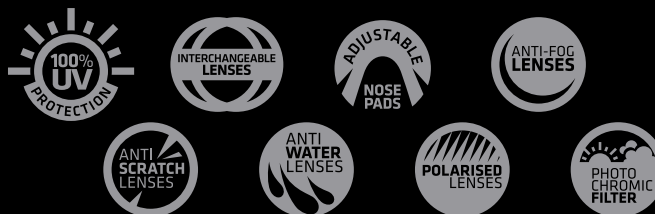

FRAME

All types of sun glasses are made of Grilamid TR90, which is characterized by an extremely high flexural strength, flexibility and lightweight. Grilamid TR90 also excellently resists weather conditions and the effects of UV radiation. This material therefore ensures a long frame durability even during high performance.

ANTI-SCRATCH COATING

All lenses are equipped with special surface treatment which increases scratch resistance.

ANTI-FOG COATING

This lens treatment prevents fogging for certain time to avoid reduced visibility.

ANTI-WATER COATING

Surface treatment improves off-take of water droplets. It helps to keep the vision clear and without any distortion.

POLYCARBONATE LENSES

These lenses are characterized by lightweight and depending on the finish also by high durability and scratch-resistance.

PHOTOCHROMIC LENSES

Photochromic lenses are made of Polycarbonate. Depending on the intensity of UV radiation the lenses will be darker. If the UV radiation is removed (indoors or inside the car), the lenses will return to their clear state. These lenses are recommended to use outdoor only.

POLARIZED LENSES

The sun light itself is not polarized – it becomes polarized after the impact on a shiny surface (snow, water surface or road), when the reflected waves oscillate in two levels – horizontal and vertical. Sunglasses with polarized filter allow only the positive vertically reflected rays to reach your eye. Looking through such sunglasses is comfortable, clear and without glare. The horizontal group of sun rays is blocked out by the polarized filter. These lenses allow a colorful vision, better visual clarity and notable relief for the eyes.

FILTER CATEGORY	TINT	USE	LIGHT TRANSMITTANCE	
			From %	To %
0	Clear / Very Light	Cloudy, Evening	80	100
1	Light Tint	Cloudy Conditions	43	80
2	Medium Tint	Regular Conditions	18	43
3	Dark Tint	Sunny Conditions (sea, mountains)	8	18
4	Very Dark*	Very Sunny (glacier)	3	8

*Inappropriate for driving a vehicle and for using in road traffic





HELMETS

RAZOR



RAZOR

ENDURO HELMET WITH MIPS®

WHEN HITTING THE MOST DEMANDING TRAILS THE ONLY THING YOU WANT TO FOCUS ON IS JUST RIDING. YOUR CONFIDENCE CANNOT BE SACRIFICED FOR ANYTHING ELSE, ESPECIALLY FOR SAFETY AND COMFORT. THEREFORE KELLYS DESIGN TEAM CREATED A BRAND NEW RAZOR - ONE OF THE MOST ADVANCED ENDURO HELMETS EVER PRODUCED.



BENEFITS

Thanks to MIPS Brain Protection System Razor gives added protection against rotational violence to the brain during an angled impact.

Razor allows you to stay cool and comfortable on trail much longer than other helmets.

Because style really matters, you can match your Razor perfectly to your preferences and find your own colour combination. Each Razor comes with an additional spare visor.

Razor provides you with safety, comfort and style – all you need to do is just ride. Ride hard.

To prevent accidental damage of your Razor and keep it in fine shape for a long time each helmet comes with a special protective bag.

Analytical section of the RAZOR helmet displaying the MIPS low friction layer



THIS IS HOW MIPS WORKS

TAKING A FALL WITH A MIPS HELMET IS VERY DIFFERENT



Almost every time you fall*, you fall at an angle. This generates rotational violence to the brain causing concussions and more severe injuries.

A TRADITIONAL HELMET

Helmets are designed and optimized for a straight fall, giving no consideration to the angled impact. All rotational violence is absorbed by the head and the brain.

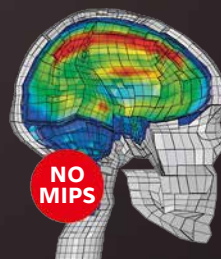

Rotational violence with standard helmet

RAZOR HELMET EQUIPPED WITH MIPS®

MIPS is a low friction layer inside the helmet that makes the outer shell of the helmet to rotate relative to the head. This can reduce strain in the brain during angled impacts.

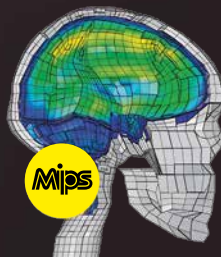

Rotational violence using a helmet with MIPS®

STRAIN LEVEL High  Low

*Get more facts about MIPS at www.mipshelmet.com or www.facebook.com/MIPShelmet



RAZOR
ocean blue



RAZOR
tiffany green



RAZOR
light blue



RAZOR
space black



RAZOR
lime green

RAZOR ENDURO HELMET

Razor helmet provides you safety, comfort and style - all you need to do is just ride. Razor is our top Enduro and MTB helmet made by In-mold technology. 23 air channels and rear vents for perfect head ventilation and optimum airflow. New adjusting system provides 5 vertical adjustable positions in rear part and 2 adjustable positions in front part. With HD Camera Platform you can easy mount your action camera on the top of the shell. Because style really matters, you can match your Razor perfectly to your preferences and find your own colour combination. Each Razor comes with additional spare visor and soft fabric protective bag.



RAZOR
juicy orange



SPARE VISORS
AVAILABLE



COLORS FOR RAZOR AND RAZOR MIPS:

ocean blue (main visor - lime green, spare visor - ocean blue)
lime green (main visor - ocean blue, spare visor - lime green)
light blue (main visor - dusty grey, spare visor - blueberry syrup)
juicy orange (main visor - ruby red, spare visor - juice orange)
space black (main visor - space black, spare visor - juice orange)
tiffany green (main visor - candy pink, spare visor - dusty grey)
SIZES: S/M (54-57 cm), L/XL (57-61 cm)



RAVE

TRAIL HELMET

Stylish and durable MTB model made by In-mould technology. Light weight and 16 big vents ensures comfort and full ventilation on the trail. Your safety is secured by easy-quick head size adjustment and special magnetic Fidlock buckle. Opening of Fidlock buckle by sliding laterally using just two fingers, so you can open it in gloves or with numb fingers easily. Inner anti-bacterial padding and removable visor included. Increased visibility by reflective stickers on the back of the helmet

COLORS: black matt, white matt, blue matt, green matt

SIZES: S/M (55-61cm), M/L (60-64 cm)



DARE

TRAIL HELMET

All-mountain model made by In-mould technology 23 air vents, air channels and rear vents for perfect head ventilation and optimum airflow STL 3.0 (Simply Twist Lock 3.0) new vertically adjustable head lock system for snug and secure fit, anti-insect internal netting, removable visor, inner padding for comfortable wearing. Increased visibility by reflective stickers on the back of the helmet

COLORS: black matt, white matt, green matt, red matt, turquoise matt, purple matt

SIZES: S/M (54-57cm), M/L (58-61cm)



SCORE

MTB-XC HELMET

Top MTB model made by In-mould technology 23 air vents, air channels and rear vents for perfect head ventilation and optimum airflow STL 2.0 (Simply Twist Lock 2.0) new vertically adjustable head lock system for snug and secure fit, anti-insect internal netting, removable visor, inner padding for comfort.

COLORS: black-silver, black-red, neon lime, white-black, dark purple

SIZES: S/M (54-57 cm), M/L (57-61 cm)



JESTER

YOUTH MTB-XC HELMET

Lightweight helmet made by in-mold technology with 13 big vents ensuring comfort and safety during hard rides. New adjusting system for snug and secure fit. Anti-bacterial inner padding and removable visor included.

COLORS: black-grey, black-violet, black-green, green

SIZES: 52-57cm



DYNAMIC

MTB-XC HELMET

Made by In-mold technology, 20 vents for perfect head ventilation, head adjustment, STL 3.0 (Simply Twist Lock 3.0) new head lock system for snug and secure fit, inner padding for comfortable wearing, anti-insect internal netting and visor.

COLORS: black-silver, black-green, white, deep blue, light blue

SIZES: S/M (54-58cm), M/L (58-61cm)



BLAZE

MTB-XC HELMET

19 vents for perfect head ventilation, easy and quick head size adjustment, STL 3.0 (Simply Twist Lock 3.0) new head lock system for snug and secure fit, inner padding for comfortable wearing and new visor. Increased visibility by reflective stickers on the back of the helmet.

COLORS: green matt, black matt, red matt, white, blue, purple

SIZES: S/M (54-57cm), M/L (58-64cm)



Kellys RESULT - lightweight bicycle helmet with magnetic strap buckle intended for road cycling. Durable In-Mold design with 24 vents ensures thermal comfort, lightness and safety for every road cyclist. Multi-directional size adjustment and soft padding provide precise and secure fit. Thanks to one-hand magnetic strap buckle, Kellys RESULT is easy and safe to wear.



- In-Mold design for lightness and safety
- One-hand magnetic strap buckle
- Multi-directional size adjustment with user-friendly knob
- Soft padding for comfy and secure fit
- 24 air vents for thermal comfort



SPURT

ROAD RACING HELMET

Road racing helmet made by In-mold technology with aerodynamic profile. Comfort during long road rides and races is increased by 27 vents for full ventilation. STL 4.0 (Simply Twist Lock 4.0) new adjusting system for more secure and comfortable fit. Quick and easy opening by sliding laterally using just two fingers thanks to special magnetic Fidlock buckle. Comfortable antibacterial inner padding. Increased visibility by reflective stickers on the back of the helmet.

COLORS: white, grey, blue, neon yellow
SIZES: S/M (52-58 cm), M/L (58-62 cm)

RESULT

ROAD RACING HELMET

Result is a top road racing helmet made by in-mold technology. Result is combining aerodynamic profile and lightweight structure with 24 enormous ventilation holes ensuring great airflow and comfort during long rides and races. New vertically adjustable head lock system for snug and secure fit. Quick and easy opening by sliding laterally using just two fingers thanks to special magnetic Fidlock buckle. Comfortable antibacterial inner padding. Increased visibility by reflective stickers on the back of the helmet.

COLORS: grey matt, white matt, green matt, blue matt
SIZES: S/M (54-58 cm), M/L (58-61 cm)





TOWN CAP
HELMET

Made by In-mold technology with 10 huge vents for perfect head ventilation. Inner padding for comfortable wearing with fabric visor. Removable visor.

COLORS: black matt, white matt, navy blue
SIZES: S/M (54-57cm), M/L (57-61cm)



JUMPER
BMX/DIRT HELMET

BMX/Dirt model with an EPS Inner shell designed to absorb the force of an impact, high of ABS outer shell strength provides protection, 12 air vents for cooling STL 3.0 (Simply Twist Lock 3.0) new vertically adjustable system for snug and secure fit, inner padding for comfort.

COLORS: black, white
SIZES: S/M (54-57cm), M/L (58-61cm)



JUMPER MINI

KIDS HELMET

Kids BMX model with an EPS Inner shell designed to absorb the force of an impact, high of ABS outer shell strength provides protection, 12 air vents for cooling STL 3.0 (Simply Twist Lock 3.0) new vertically adjustable system for snug and secure fit, inner padding for comfort.

COLORS: black, lime, red, blue
SIZES: XS/S (51-54 CM)



ACEY

KIDS HELMET

Helmet designed to increase children protection. Durable In-mold technology. Cooling is secured by 10 vents. Helmet has antibacterial padding and small integrated visor. Visibility is increased by reflective stickers on the back of the helmet. Adjusting system with big wheel for easy manipulation for kids and their parents also.

COLORS: black, blue, green, pink, red, white
SIZES: XS 45-49cm, S 49-53cm



ZIGZAG

KIDS HELMET

Helmet designed to increase children protection. Cooling is secured by 8 vents. Helmet has antibacterial padding and small integrated visor. Visibility is increased by reflective stickers on the back of the helmet. Adjusting system with big wheel for easy manipulation for kids and their parents also.

COLORS: blue, mint, pink, purple, lime
SIZES: XS 45-49cm, S 49-53cm





BACKPACKS

SWITCH



Perforated EVA shoulder straps

Two way adjustable chest strap for perfect fit

Lightweight and airy 3D foam back panel for thermal comfort

Wide and comfortable load bearing waist belt to hold backpack in place



KLS SWITCH 18

BACKPACK WITH BACK PROTECTOR

Made of Nylon 420D ripstop PU coated – durable and lightweight fabric
Integrated backprotector insert is certified according to EN 1621-2:2014
Detachable backpack part allows to use only backprotection panel and waterbladder

Helmet carriers for Full face and MTB helmet (all straps are hideable)

Separate section for water bladder (carry up to 3l water bladder)

Sunglasses/goggles padded compartment

Inside sections for small goods such as tube, tire levers, pump, tools etc.

Flexible and comfortable waist belt.

Waterproof cover included

Tail light clip

VOLUME: 18L

Integrated backprotector insert is certified according to EN 1621-2:2014

Glove friendly zipper pullers





Dedicated compartments to keep everything in order



Soft padded glass/goggle compartment



Durable and tear resistant Nylon 420D fabric with weather proof coating

KLS

Integrated rain cover

Helmet carrying system with hiddable straps for clean look

Detachable backpack part allows to use only backprotection panel and waterbladder



KLS JET 8

BACKPACK

Made of Nylon 420D ripstop PU coated – durable and lightweight fabric
Helmet carrier (straps are hideable)
Water bladder compartment
Sunglasses padded compartment
Inside sections for small goods such as tube, tire levers, pump, tools etc.
Detachable hip belt straps
Waterproof cover included
Tail light clip
VOLUME: 8L



LANE 10

BACKPACK

Made of Nylon 210D ripstop PU coated – durable and lightweight fabric
Helmet carriers for Full face and MTB helmet (straps are hideable)
Knee/elbow pad holder (straps are hideable)
Water bladder compartment (carry up to 3l water bladder)
Sunglasses/goggles padded compartment
Inside sections for small goods such as tube, tire levers, pump, tools etc.
Flexible and breathable hip belt straps
Waterproof cover
Tail light clip
VOLUME: 10L



LANE 16

BACKPACK

Made of Nylon 210D ripstop PU coated – durable and lightweight fabric
 Helmet carriers for Full face and MTB helmet (straps are hideable)
 Knee/elbow pad holder (straps are hideable)
 Separate section for water bladder (carry up to 3l water bladder)
 Sunglasses/goggles padded compartment
 Inside sections for small goods such as tube, tire levers, pump, tools etc.
 Flexible and breathable hip belt straps
 Waterproof cover
 Tail light clip
VOLUME: 16L



FETCH 25

BACKPACK

Made of Nylon 210D ripstop PU coated – durable and lightweight fabric
 Helmet carriers for Full face and MTB helmet (straps are hideable)
 Knee/elbow pad holder (straps are hideable)
 Separate section for water bladder (carry up to 3l water bladder)
 Sunglasses/goggles padded compartment
 Inside sections for small goods such as tube, tire levers, pump, tools etc.
 Flexible and breathable hip belt straps
 Waterproof cover
 Tail light clip
VOLUME: 25L



TRANSIT

TRAVEL BAG

Made of Polyester 600D PU coated – durable and long lasting fabric
Travel bag in cabin luggage size (55 cm x 38 cm x 20 cm
will fit most of the airlines)

Skate silicone wheels

Shoes compartment (shoes are separated from everything else)

Laptop compartment

(soft padding with EVA foam)

Tablet compartment and document organiser

2 inside organizers for small goods.

3 positions aluminium alloy handle

VOLUME: 40L (expandable to 60L)





DAKOTA

WAIST BAG

Made of Polyester 600D/ 210 Nylon
Airflow contact system
Side bottle holders
Main pocket with inside organizing pockets
Softened front pocket with organizing pockets
Hip-belt pockets

VOLUME: 5L

Dimensions: 24cm x 19cm x 12cm



TANK 30

WATER BLADDER

Made of PEVA
Wide opening Slide lock system for easy and comfort filling and cleaning
Detachable 100cm PVC tube with valve water lock system
Neoprene sleeve on PVC tube included

VOLUME: 3L



TANK 20

WATER BLADDER

Made of PEVA
Wide opening Slide lock system for easy and comfort filling and cleaning
Detachable 100cm PVC tube with valve water lock system
Neoprene sleeve on PVC tube included

VOLUME: 2L



ACCESSORIES

BICYCLE





MISSION:

THE DARK RIDER



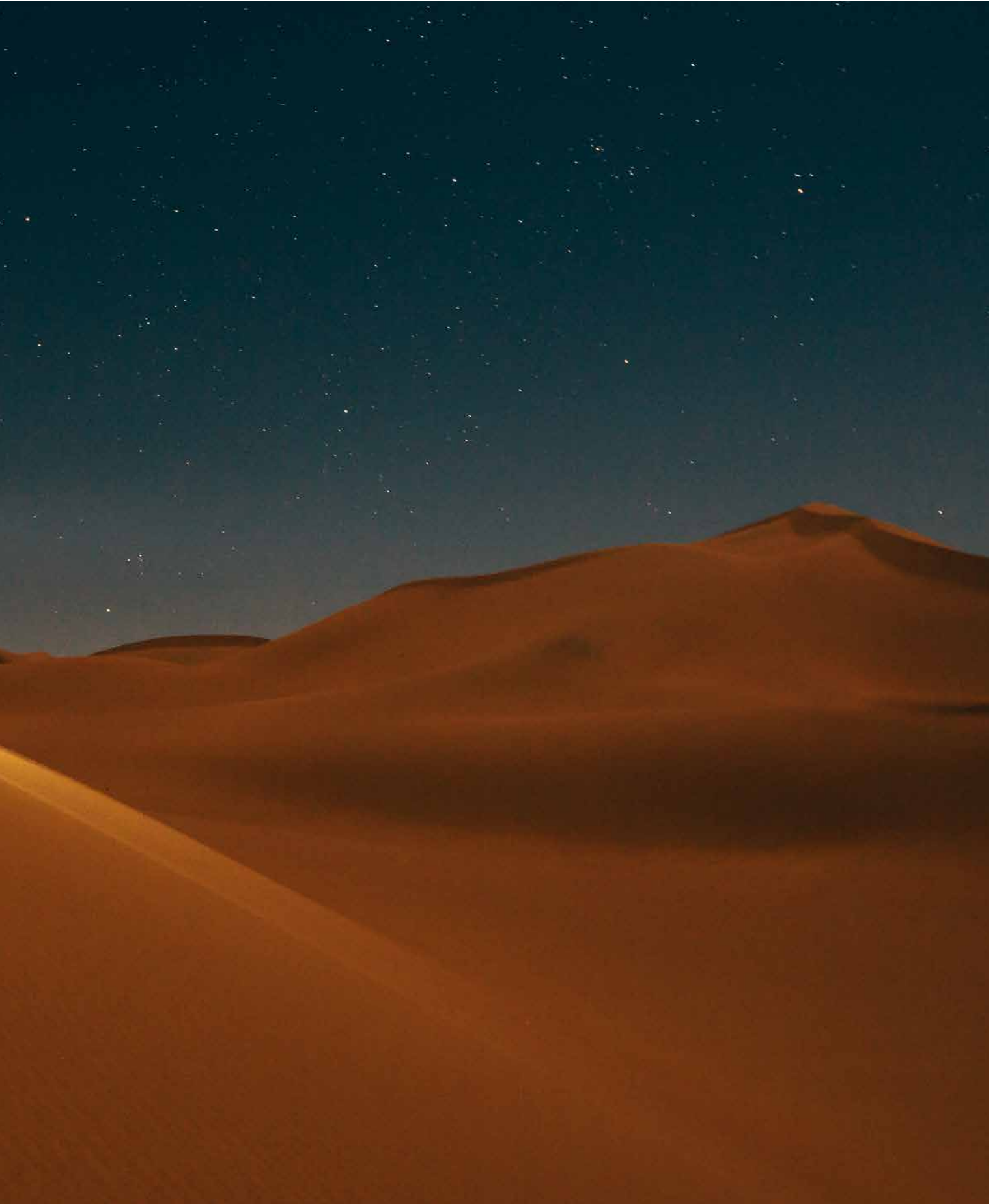



LIGHTS

IT'S NOT ALL ABOUT THE LUMENS
- OPTICS MATTERS!

IF YOU HAVE A HI-POWER LIGHT WHICH SENDS ALL THE LIGHT INTO ONE SMALL POINT IN THE DISTANCE - YOU WON'T SEE MUCH WITH YOUR 6 000 LUMEN LIGHT. LENS AND REFLECTOR NEEDS TO DIRECT A STRONG BEAM OF LIGHT INTO THE DISTANCE, WHILE A WIDE-ANGLE OF "DIMMER" LIGHT IS DISTRIBUTED EVENLY AT YOUR SURROUNDINGS.

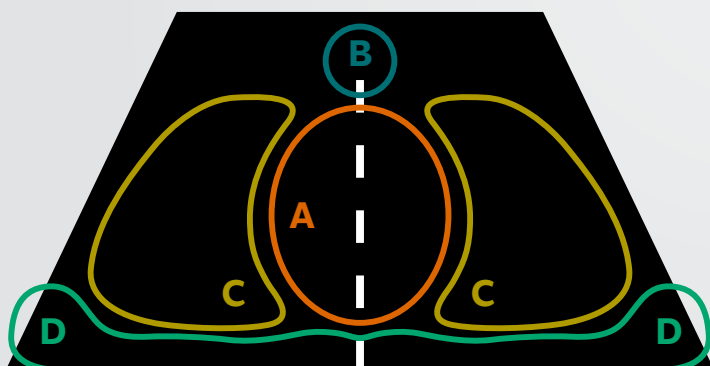

There are 4 zones which needs appropriate lightning:

- A - CENTER AREA
- B - FAR DISTANCE
- C - SIDE AREAS
- D - VERY CLOSE DISTANCES

Good optics take care about all the areas.
For us in KLS - this is the very basics of „good light“.



A lot of lights on the market takes care only about the zone „A“

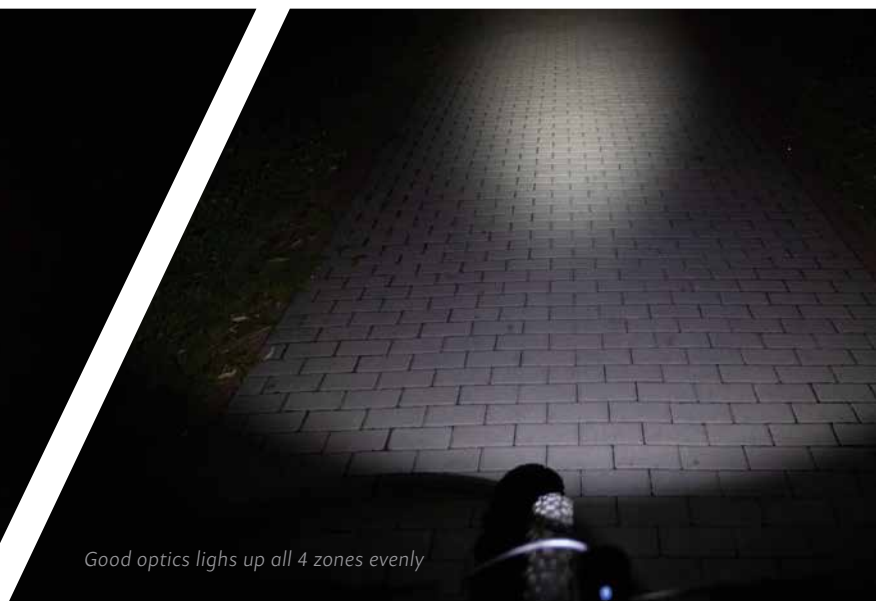

Good optics lighs up all 4 zones evenly



ZOOMER

HEADLIGHT

Zoom lens: 3-140°

Source of light: 1x XM-L T6 LED (USB) / 1x Cree LED (AAA)

Functions: 100%, 50%, 25%, Flashing

Double-click for turning ON, long-press for turning OFF

Battery lifetime (AAA): 60hrs (100%), 30hrs (50%), 15hrs (25%), 180hrs (Flashing)

Battery lifetime (USB): 3hrs (100%), 6hrs (50%), 12hrs (25%), 12hrs (Flashing)

Battery indicator (USB): Off (100-25%), Red (24-5%), Flashing Red (<5%)

Charging time: (USB) 5,5 hrs

Battery type: 18650 Li-ion 3,7 V 2400 mAh (USB) / 3x AAA (included)

USB cable included (USB)

Universal tool-free bracket fits all common handlebars

IPX 4 (Water resistant)

COLOR Rings (included in packaging):

Red, Green, Blue, Purple, Black

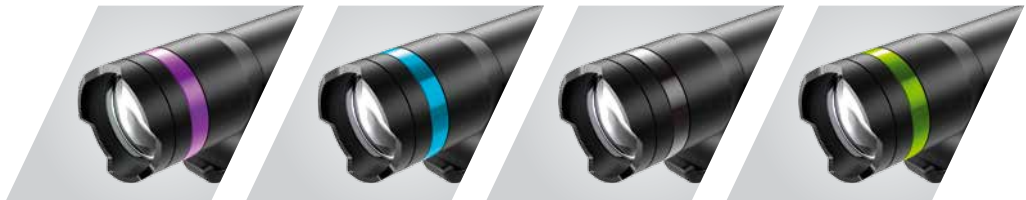
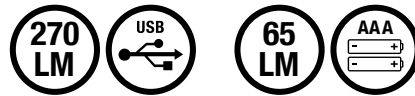



PERSEUS

RECHARGABLE HEADLIGHT

Source of light: 1 x XPE LED
 Functions: 100%, 50%
 Battery lifetime: 3hrs (100%), 6hrs (50%),
 Battery indicator: Green (100-25%), Red (24-5%), Flashing Red (<5%)
 Charging time: 2.5 hrs
 Battery type: Li-ion 3.7 V, 1200 mAh
 USB cable included
 Universal size bracket fits all common handlebars
 IPX 4 (Water resistant)
COLOR: Black



StVZO
ZUGELASSEN



PERSEUS SET

HEADLIGHT / TAILLIGHT

ILLUX

RECHARGABLE TAILLIGHT

Source of light: 16 x COB LED
 Functions: 100%
 Battery lifetime: 2hrs
 Battery indicator: ON (100-75%), Pulse (74-50%), Flashing (49-25%),
 Rapid flashing (24-0%)
 Charging time: 1hr
 Battery type: Li-pol, 3.7V, 500mAh
 USB cable included
 Adjustable tool-free strap fits all common seatposts / aero seatposts
 IPX 4 (Water resistant)



StVZO
ZUGELASSEN

REVOLT USB

RECHARGABLE HEADLIGHT

Source of light: 1x LED
Functions: 100%, 50%
Double-click for turning ON, long-press for turning OFF
Battery lifetime: 3,3hrs (100%), 6,6hrs (50%)
Battery indicator: Red = 45 min (100%), Flashing Red = 10 min (100%)
Charging time: 5,5 hrs
Battery type: 18650 Li-ion 3,7 V 1300 mAh
USB cable included
360° adjustable, tool-free bracket fits all common handlebars
IPX 4 (Water resistant)
COLOR: Black

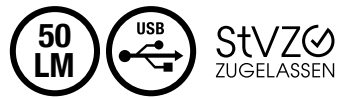

PROXIMO

RECHARGABLE TAILLIGHT

Source of light: 1 x UltraBright LED
Functions: 100%
Battery lifetime: 3hrs
Battery indicator
Charging time: 2hrs
Battery type: Li-pol 240mAh
USB cable included
IPX 4 (Water resistant)
Horizontally adjustable tool-free bracket fits all common seatposts

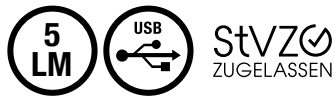

NOBLE SET USB

HEADLIGHT / TAILLIGHT





REVOLT

HEADLIGHT



Source of light: 1x LED
 Functions: 100%, 25%, Flashing
 Double-click for turning ON, long-press for turning OFF
 Battery lifetime: 48hrs (100%), 195hrs (25%) 300hrs (Flashing)
 Battery type: 2x AA (included)
 360° adjustable, tool-free bracket fits all common handlebars
 IPX 4 (Water resistant)
COLOR: Black

50 LM



RIPPY

TAILLIGHT

Source of light: 3x LED
 Functions: 100%, 50%, Flashing
 Battery lifetime: 140hrs (100%), 168hrs (50%) 280hrs (Flashing)
 Battery type: 2x AAA (included)
 Adjustable tool-free bracket fits all common seatposts
 IPX 4 (Water resistant)

13 LM



STRIKE SET

HEADLIGHT / TAILLIGHT



NOBLE SET

HEADLIGHT / TAILLIGHT

Source of light: 1x LED
 Functions: 100%, 25%, Flashing
 Double-click for turning ON, long-press for turning OFF
 Battery lifetime: 48hrs (100%), 195hrs (25%) 300hrs (Flashing)
 Battery type: 2x AA (included)
 360° adjustable, tool-free bracket fits all common handlebars
 IPX 4 (Water resistant)
COLOR: Black

Source of light: 2x LED
 Functions: 100%, Flashing, Strobo
 Battery lifetime: 80hrs (100%), 160hrs (Flashing) 160hrs (Strobo)
 Battery type: 2x CR 2032 (included)
 Universal tool-free bracket fits all common seatposts
 IPX 3 (Water resistant)

50 LM 1.2 LM



ATLAS F

HEADLIGHT

Source of light: 1x Cree LED
Functions: 100%, 50%
Battery lifetime: 2.2hrs (100%), 4.5hrs (50%)
Battery indicator: Off (100-25%), Red (24-5%),
Flashing Red (<5%)
Battery type: Dynamo / 2x AA (included)
IPX 4 (Water resistant)
DIMENSIONS: 72 x 40 x 29mm
COLOR: Black



StVZO
ZUGELASSEN



ATLAS R

TAILLIGHT

Source of light: 1x Cree LED
Functions: 100%
Battery lifetime: 180hrs (100%)
Battery indicator: Off (100-25%), Orange (24-0%)
Battery type: Dynamo / 2x AAA (included)
IPX 4 (Water resistant)
Mount: 80mm
DIMENSIONS: 72 x 40 x 29mm



StVZO
ZUGELASSEN



ATLAS SET

HEADLIGHT / TAILLIGHT



KEPLER

HEADLIGHT

Source of light: 1x Cree LED
Functions: 100%
Battery lifetime: 180hrs (100%),
Battery indicator: Off (100-25%), Orange (24-0%)
Battery type: Dynamo / 2x AAA (included)
IPX 4 (Water resistant)
Mount: 80/50mm



StVZO
ZUGELASSEN



VIRGO

HEADLIGHT

Impact protective steel cage
Source of light: 1 x LED
Functions: 100%
Battery lifetime: 145hrs
Battery indicator: Off (100-25%), Orange (24-0%)
Battery type: 2x AAA (included)
Mount size 20mm
IPX 4 (Water resistant)



StVZO
ZUGELASSEN



:10 
SET

Aluminium casing
Source of light: 0,5W Cree LED
Functions: 100%, Pulse, Flashing
Double-click for turning ON
Battery lifetime: 2,5hrs (100%), 7hrs (Pulse), 13hrs (Flashing)
Battery indicator: 1xFlash (100-75%), 2xFlash (74-50%), 3xFlash (49-25%), 4xFlash (24-0%)
Charging time: 1,5 hrs
Battery type: Li-pol 220mAh
USB cable included
Adjustable tool-free strap fits all common handlebars/seatposts
IPX 4 (Water resistant)
COLORS: Blue, Red, Purple, Black





VEGA

SET



Source of light: 2x LED
 Functions: 100%, 50%, Flashing
 Double-click for turning ON, long-press for turning OFF
 Battery lifetime (CR 2032): 180hrs (100%), 360hrs (50%), 360hrs (Flashing)
 Battery lifetime (USB): 4.5hrs (100%), 9hrs (50%), 9hrs (Flashing)
 Battery indicator (USB): Off (100-25%), Red (24-0%)
 Charging time: (USB) 2,5 hrs
 Battery type: Li-ion 3,7 V 220 mAh (USB) / 2x CR 2032 (included)
 USB cable included (USB)
 Universal tool-free bracket fits all common handlebars and seatposts.
 IPX 4 (Water resistant)
COLORS: Red, Lime Green, Sky Blue, Orange, Yellow, Turquoise, Purple, Black



TWINS

SET



Source of light: 2x LED
 Functions: 100%, Flashing 1, Flashing 2
 Battery lifetime: 70hrs (100%), 140hrs (Flashing)
 Battery type: 2x CR 2032 (included)
 Universal tool-free bracket fits all common stems, handlebars and seatposts.
 IPX 3 (Water resistant)
COLORS: Red, Lime Green, Sky Blue, Orange, Yellow, Turquoise, Purple, Black



PIGGY

TAILLIGHT



Soft silicone cover
 Source of light: 2 x SuperBright red LED
 Functions: 100%, Flashing
 Battery lifetime: 70hrs (100%), 120h (Flashing)
 Battery type: 2x 2032 batteries (included)
 Adjustable tool-free strap fits all common seatposts
 IPX 3 (Water resistant)
COLORS: Blue, Green, Red, Orange, Pink, Black





SHADOW

REFLECTIVE ARMBAND

Made of high gloss 3M Scotchlite reflective film
Back side made of 100% polyester velvet fabric
Tested and certificated by TÜV Rheinland, Germany
Conforms to CE EN 13356
SIZES: 3x30cm, 3x40cm



SPARKY

LED ARMBAND

Made of high gloss 3M Scotchlite reflective film
Back side made of 100% polyester velvet fabric
Tested and certificated by TÜV Rheinland, Germany
Conforms to CE EN 13356



RADIATE

TROUSERS CLIP

Made of ABS plastic material
3M Scotchlite reflective material



TWILIGHT

REFLEX TAPE

Made of 100% Polyester
Tested and certificated by TÜV Rheinland, Germany
Conforms to CE EN 13356
SIZES: 4x40cm, 4x50cm



MOONLIGHT

ELASTIC SAFETY STRAP VEST

Universal size / uni-sex
Fully adjustable
Tested and certificated by TÜV Rheinland, Germany
Conforms to CE EN 13356



STARLIGHT

KIDS SAFETY VEST

Made of 100% Polyester
Size adjustment by velcro straps
Tested and certificated by TÜV Rheinland, Germany
Conforms to CE EN 1150
SIZES: XXS - M



TWINKLE SET

LED SAFETY REFLECTOR
WITH VELCRO CLIP

Made of high gloss 3M Scotchlite reflective film
Tested and certificated by TÜV Rheinland, Germany
Conforms to CE EN 13356



TWINKLE PRO

LED SAFETY REFLECTOR
WITH MAGNETIC CLIP

Made of high gloss 3M Scotchlite reflective film
Tested and certificated by TÜV Rheinland, Germany
Conforms to CE EN 13356



SPARKY PRO

LED ARMBAND

Made of high gloss 3M Scotchlite reflective film
Tested and certificated by TÜV Rheinland, Germany
Conforms to CE EN 13356



SCREENSHOT

WIRED CYCLE COMPUTER

10 FUNCTIONS:

- speedometer
- tripmeter (DST)
- odometer (ODO)
- auto trip timer (TM)
- maximum speed (MXS)
- digital clock
- average speed (AVS)
- scan of functions DST, MXS, AVS, TM
- speed comparator (+ / -)
- AUTOSTART

Extra big double space LCD display offers easy read-out, click release system, single-piece sensor INCLUDING MOUNTING BRACKET FOR HANDLEBAR.

BATTERY: computer- 3V CR2032

COLOR: black



REFLEX

WIRELESS CYCLE COMPUTER

15 FUNCTIONS:

- speedometer
- speed comparator (+ / -)
- tripmeter (DST)
- speed tendency (acceleration or deceleration)
- odometer (ODO)
- temperature
- auto trip timer (TM)
- calorie consumption
- maximum speed (MXS)
- total reduction of carbon dioxide emission
- digital clock - 12/24 hour selectable
- AUTO-START STOP system
- average speed (AVS)
- backlight
- scan of functions DST, MXS, AVS, TM

Double space LCD display offers easy read-out, easy tool-less fixation to handlebar or stem by reorientation silicone unit. Flexible silicone body, single-piece sensor.

BATTERY: Computer- 3V CR2032, Sensor-3V CR2032

COLORS: black, white, lime, turquoise.

SCREENSHOT WL

WIRELESS CYCLE COMPUTER

10 FUNCTIONS:

- speedometer
- tripmeter (DST)
- odometer (ODO)
- auto trip timer (TM)
- maximum speed (MXS)
- digital clock
- average speed (AVS)
- scan of functions DST, MXS, AVS, TM
- speed comparator (+ / -)
- AUTOSTART



Extra big double space LCD display offers easy read-out, click release system, single-piece sensor INCLUDING MOUNTING BRACKET FOR HANDLEBAR.

BATTERY: computer- 3V CR2032, sensor-3V CR2032

COLOR: black

DIGIT

WIRED CYCLE COMPUTER

10 FUNCTIONS:

- speedometer
- tripmeter (DST)
- odometer (ODO)
- auto trip timer (TM)
- maximum speed (MXS)
- digital clock
- average speed (AVS)
- scan of functions DST, MXS, AVS, TM
- speed comparator (+ / -)
- AUTO-START STOP system



Double space LCD display offers easy read-out, click release system, single-piece sensor including mounting bracket for handlebar.

BATTERY: computer- 3V CR2032

COLOR: black



ANTARCTICA

WATER BOTTLE 0,65L/0,5L

Original KLS design. Double wall with airspace and special aluminum foil. Bottle ANTARCTICA is a soft, lightweight, easy-to-use insulated bottle that keeps beverages cool or warm. Ultra-wide cap with rubber mouthpiece. Ultra-cap is easy to open, effortless to use, and leak-proof when closed. Made with BPA FREE technology for clean, pure refreshment. Suitable for water isotonic drinks, and other sport drinks without CO2 up to 60 °C
Made from BPA-free plastic

WEIGHT: 0,65L-160g / 0,5L - 140g

COLORS: charcoal black, shiny white



TULAROSA

WATER BOTTLE 0,75L

Original KLS design. Ultra wide cap with rubber mouthpiece. Ultra cap is easy to open, effortless to use, and leak-proof when closed. Made with BPA FREE technology for clean, pure refreshment. Suitable for water isotonic drinks, and other sport drinks without CO₂ up to 40 °C

Made from BPA-free plasticity

WEIGHT: 95g

Volume: 0,75L

COLORS: blue, green, grey, orange, red, pink



NAMIB

WATER BOTTLE 0,7L

Original KLS design. Ultra-wide cap with rubber mouthpiece. Ultra-cap is easy to open, effortless to use, and leak-proof when closed. Made with BPA FREE technology for clean, pure refreshment. Suitable for water isotonic drinks, and other sport drinks without CO2 up to 60 °C

Made from BPA-free plastic

WEIGHT: 82g

COLORS: anthracite-white, transparent-lime, transparent-blue, transparent-pink, transparent-black



MOJAVE

WATER BOTTLE 0,5L

Original KLS design. Wide cap with rubber mouthpiece. Made with BPA FREE technology for clean, pure refreshment. Suitable for water isotonic drinks, and other sport drinks without CO2 up to 40 °C

Made from BPA-free plastic

WEIGHT: 68 g

VOLUME: 0,5L

COLORS: transparent white, transparent grey, transparent blue, transparent green



SPORT

WATER BOTTLE 0,7L

Ergonomic shape and original design, wide bottle-neck for easy cleaning and filling, soft lockable mouthpiece from soft plastic BergaFlex™, made of high quality and proper hygienic, materials polypropylene Borealis / Mosten,

WEIGHT: 75g

COLORS: white, blue, lime, red, green, antracit



KALAHARI

WATER BOTTLE 1L

Original Kellys design, Wide bottleneck for easy cleaning and filling, Soft lockable mouthpiece made of soft plastic BergaFlex™, Made of high quality polyethylene, Suitable for water, isotonic drinks and other sport drinks without CO2 up to 40°C,

WEIGHT: 117g

COLORS: semi-transparent anthracite-red, semi-transparent white-grey



ATACAMA

WATER BOTTLE 0,65L

Original KLS design. Made with BPA FREE technology for clean, pure refreshment. Rubber mouthpiece with dust cover. Mount piece is easy to open, effortless to use, and leak-proof when closed. Suitable for water isotonic drinks, and other sport drinks without CO2 up to 40 °C

Made from BPA-free plastic

WEIGHT: 80g

COLORS: black, orange, green, purple, tiffany blue



RANGIPO JUNIOR

WATER BOTTLE 0,38L

Original KLS design fits children bikes. Made with BPA FREE technology for clean, pure refreshment. Childproof undetachable rubber mouthpiece to avoid suffocation. Mount piece is easy to open, effortless to use, and leak-proof when closed. Suitable for water isotonic drinks, and other sport drinks without CO2 up to 40 °C

Made from BPA-free plastic

WEIGHT: 60g

COLORS: blue, pink





SIDEWINDER

BOTTLE CAGE

Side bottle cage for narrow bike frames
Material aluminum alloy 6463-T5
Including 2 stainless steel bolts
WEIGHT: 35g
COLORS: black, white



BULLET

BOTTLE CAGE

Elastic tensioner for a secure bottle hold
Material aluminum alloy 5052
Including 2 stainless steel bolts
WEIGHT: 26g
COLORS: grey, white, lime



BALLISTIC

BOTTLE CAGE

Side bottle cage for narrow bike frames
One piece nylon material
Including 2 stainless steel bolts
WEIGHT: 50g
COLORS: black, white



SQUAD

BOTTLE CAGE

Material plate aluminum alloy 6061-T5
press-molding
Including 2 stainless steel bolts
WEIGHT: 47g
COLORS: lime, blue, sky, green, orange,
grey, white-grey



CURE NYLON

BOTTLE CAGE

One piece nylon material
Including 2 stainless steel bolts
WEIGHT: 29g
COLORS: white, black, lime, grey



PACIFIC

BOTTLE CAGE

Bottle cage made of resistant material Nylon 66
2 stainless steel bolts included

WEIGHT: 32g
COLORS: black, lime, pink



CALIBER

BOTTLE CAGE

Material aluminum alloy 6063 and nylon
Including 2 stainless steel bolts

WEIGHT: 40g
COLORS: black, grey, lime



PATRIOT

BOTTLE CAGE

One piece polycarbonate material
Including 2 stainless steel bolts

WEIGHT: 33g
COLORS: red, black- blue, white,
black, lime, orange



RATIO

BOTTLE CAGE

Material aluminum alloy 6463-T5
Including 2 stainless steel bolts

WEIGHT: 59g
COLORS: black, grey, silver



SLOT

BOTTLE CAGE MOUNT

Ø22mm - 31.8mm
Universal plastic bottle cage
mount adjustable for handlebars
and seat post
Rubber pads for a better grip
and scratch protection



RATIO JUNIOR

BOTTLE CAGE

Material aluminum alloy 6463-T5
Including 2 stainless steel bolts

Weight 59g
COLORS: silver, black



PUMPS

AIRTANK





Tank charge/wheel direct pump switch



Heavy-duty alloy 3-in-1 valve head - Presta, Schrader, and Dunlop-type compatible



Hi-volume pressure tank provides an instant air blast for easy tubeless tire fitment



Accurate pressure gauge for precise pressure measurement up to 240psi/18bar



Ergonomic rubber-coated handle and solid base for comfort and safety
Elastic hi-pressure hose (125 cm)

AIRTANK

FLOOR PUMP

Alloy service pump with Airtank
Inflates tubeless ready tires
Switchable Schrader/Presta/Dunlop
Ergonomic handle for comfortable pumping
Stable die-cast base covered by rubber for even better stability
Top mounted gauge

MAXIMUM PRESSURE:

240 psi/18 bar



AIRFLOW ONE

FLOOR PUMP

Alloy Service pump
Large pressure gauge in base for easy reading
Ergonomic handle
Dual head for Schrader/Presta/Dunlop
Hose **LENGTH:** 940mm
Handle: 240 x 37mm

MAXIMUM PRESSURE:
160 psi/11 bar

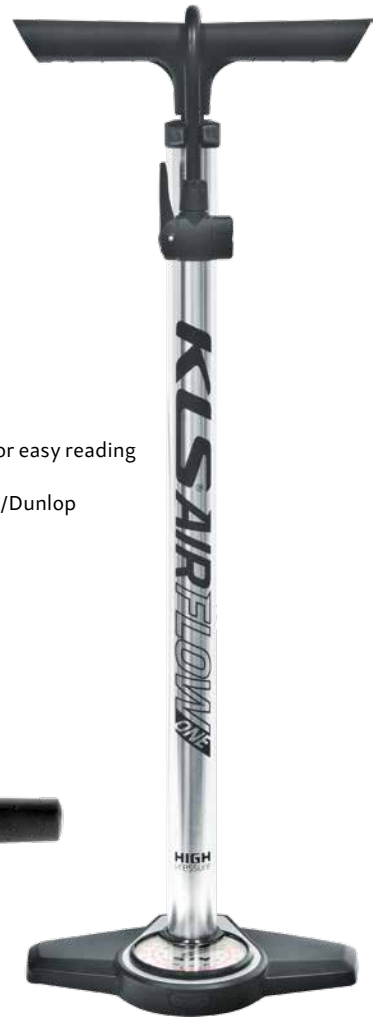

AIRFLOW TWENTY FIVE

FLOOR PUMP

High pressure aluminum service pump
Die casting aluminum base
Two-sided valve suitable for Schrader, Presta and Dunlop
Large 3" base mounted gauge, easy to read
Hose **LENGTH:** 126cm
Handle: 27 x 3.7 cm

MAXIMUM PRESSURE:
260psi / 18 bar



MAGNUM

FLOOR PUMP

Alloy floor pump
Pressure gauge
Dual head for Schrader/Presta/Dunlop
Ergonomic handle with rubber grip zones
Stable base

MAXIMUM PRESSURE:
160 psi/11 bar



TWISTER PRO

FLOOR PUMP

Light weight plastic pump
Wider shaft for easy pumping
Dual head for Schrader/Presta/Dunlop
Wide base for stability
Half-height big round gauge

MAXIMUM PRESSURE:

160 psi/11 bar



TWISTER

FLOOR PUMP

Light weight plastic pump
Wider shaft for easy pumping
Dual head for Schrader/Presta/Dunlop
Wide base for stability

MAXIMUM PRESSURE:

160 psi/11 bar



CLASSIC

TRAVELPUMP

Aluminium alloy pump
Combination of minipump with performance of floor pump
Hose ergonomically nested in oval
Reversible head for Schrader/Presta valve
Foldable T-handle
Integrated metal pedestal, including frame bracket

WEIGHT: 209g

MAXIMUM PRESSURE:

120psi/8 bar



COVERT

PUMP

Compact mini floor pump usable also as portable hand pump
1" pop-out precise hideable gauge - sliding out by stepping down metal footpad
18mm alloy telescopic barrels for Big-Volume/Hi-Pressure modes
Pinch-Free T-handle
CNC valve core and cap
Patented auto-switching Twin Head fits schrader/presta with thread for valve engagement
Valve head with plugs against dust

LENGTH: 300mm

WEIGHT: 216g

MAXIMUM PRESSURE:

120psi/8 bar

OMNI

MINIPUMP

All in one mini pump
Shock/Schrader/Presta/Dunlop
Multi-directional hose
Bleeder for fine tuning pressure
Gauge for Bar/PSI reading
High pressure – Big volume switch

WEIGHT: 218g

LENGTH: 260mm

MAXIMUM PRESSURE:

300 psi



DRIFT

MINIPUMP

Minipump suitable for MTB
Made by CNC technology
Patented auto switching dual head fits Schrader /Presta
Big barrel
Length: 215mm

MAXIMUM PRESSURE:

80psi/5 bar



PULSE

MINIPUMP

Compact- lightweight - plastic body
Reversible Schrader/Presta
Thumb Lock system
Space in the handle for repair set
or tools.

Including bracket

LENGTH: 255mm

WEIGHT: 130g

MAXIMUM PRESSURE:

80psi / 5 bar



DOUBLY PRO 30

ERGONOMIC ALLOY MINI PUMP

Dual head for Schrader/Presta/Dunlop
Ergonomic T-Lock handle

WEIGHT: 137g

LENGTH: 265mm

MAXIMUM PRESSURE:

80psi/5 bar



DOUBLY PRO 10

ERGONOMIC PLASTIC MINI PUMP

Dual head for Schrader/Presta/Dunlop
Telescopic

Ergonomic T-Lock handle

WEIGHT: 128g

LENGTH: 265mm

MAXIMUM PRESSURE:

100psi/7 bar



DOUBLY PRO 50

ERGONOMIC ALLOY MINI PUMP

Dual head for Schrader/Presta/Dunlop
Telescopic

Ergonomic T-Lock handle

WEIGHT: 153g

LENGTH: 265mm

MAXIMUM PRESSURE:

100psi/7 bar



SHOCKER 70

HIGH-PRESSURE PUMP

Alloy high pressure pump
With pressure gauge
Covered fine tuning pressure
bleeding valve
Swivel hose for easy pumping
Ergonomic handle

LENGTH: 260mm

WEIGHT: 190g

MAXIMUM PRESSURE:

300 psi/20 bar

SHOCKER 50

HIGH-PRESSURE PUMP

With pressure gauge
Fine Tuning pressure bleeding valve
2-stage non-leakage valve
Swivel hose for easy pumping
Plastic upper & lower handles
Pinch-Free locked T-handle

LENGTH: 260mm

WEIGHT: 190g

MAXIMUM PRESSURE:

300 psi/20 bar



HOW TO CHOOSE A LOCK

	SHORT STOPS	FEW HOURS	OVERNIGHT
VERY BUSY OR ABANDONNED AREA	6-7 <i>High Security</i>	9-10 <i>Extreme Security</i>	9-10 <i>Extreme Security</i>
CITY CENTRES AND CLOSE SURROUNDINGS	4-5 <i>Medium Security</i>	6-8 <i>High Security</i>	9-10 <i>Extreme security</i>
SUBURBS	2-3 <i>Light Security</i>	4-5 <i>Medium security</i>	6-8 <i>High Security</i>
COUNTRYSIDE	1-3 <i>Light Security</i>	1-3 <i>Light Security</i>	4-5 <i>Medium security</i>

FOLDING LOCKS

THEY ARE SMALL IN SHAPE AND EASY TO CARRY ON YOUR BIKE THANKS TO A BRACKET INCLUDED WITH EVERY LOCK. FOLDING LOCKS OFFER GREAT WEIGHT TO STRENGTH RATIO. THANKS TO THE CONNECTION POINTS LOCKS ARE EASY TO OPERATE. TWO KEYS ARE INCLUDED WITH EVERY FOLDING LOCK.



FOLD 90
FOLDING LOCK



FOLD 70
FOLDING LOCK



FOLD 50
FOLDING LOCK



FOLD 30
grey

FOLD 30
green



FOLD 30
FOLDING LOCK



FOLD 30
blue



CHAINLOCKS

THESE ARE HEAVY DUTY LOCKS OFFERING MAXIMUM SECURITY FOR YOUR BICYCLE. YOU CAN EASILY CARRY THEM AROUND THE SEATPOST. POLYESTER SLEEVE PROTECTS YOUR BIKE FROM SCRATCHES. CHAINLOCKS HAVE TWO OPTIONS TO CHOOSE FROM - EITHER KEY SYSTEM OR COMBINATION DIAL.



CHAINLOCK 8

STEEL CHAIN LOCK



CHAINLOCK 10

STEEL CHAIN LOCK



CHAINLOCK 6

COMBINATION STEEL CHAIN LOCK



CHAINLOCK 4

COMBINATION STEEL CHAIN LOCK



U-LOCKS

OFFERS EXTREME SECURITY FOR YOUR BIKES. THEY ARE EASY TO CARRY ON THE FRAME OF THE BICYCLE.

DUST CAP ON LOCK CYLINDER PREVENT DUST GATHERING AT THE LOCKING AREA.

PLASTIC COVER WILL PROTECT YOUR BIKE AGAINST SCRATCHES.

BLOCK

STEEL U-LOCK



ALERT PLUS

STEEL U-LOCK



HARDCOIL

SPIRAL CABLE LOCK

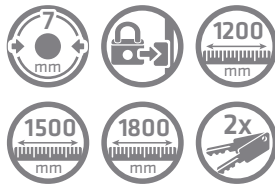

SPIRAL CABLE LOCKS

LOCKS WITH GREAT WEIGHT TO STRENGTH RATIO. THEY ARE EASY TO CARRY THANKS TO THE BRACKET INCLUDED WITH EVERY LOCK. NEW TECHNOLOGY KEY AND LOCK CYLINDER. PLASTIC COVER ON INNER WIRE WILL KEEP YOUR BIKE SCRATCH FREE. TWO KEYS ARE INCLUDED WITH EVERY LOCK.

RECOIL

SPIRAL CABLE LOCK

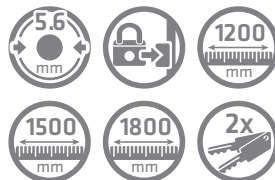

COIL

SPIRAL CABLE LOCK

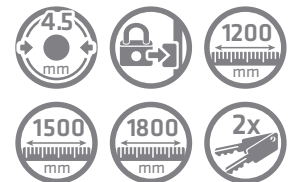



COMBINATION SPIRAL CABLE LOCKS

THESE LIGHT WEIGHT LOCKS WITH SMALL SIZE CABLE ARE EASY TO STORE AND CARRY ON BICYCLE. PLASTIC COVER ON INNER WIRE WILL KEEP YOUR BIKE SCRATCH FREE AND THANKS TO DIAL SYSTEM YOU WON'T NEED TO CARRY AROUND THE LOCK KEYS.

CRYPT orange

CRYPT blue

CRYPT lime

CRYPT black



CRYPT COMBINATION SPIRAL CABLE LOCK



ENCODE COMBINATION SPIRAL CABLE LOCK



CODE COMBINATION SPIRAL CABLE LOCK





SUNNY
pastel green

SUNNY
pastel pink

SUNNY

CABLE LOCK WITH SILICON COVER



CABLE LOCKS

THESE LIGHT LOCKS WITH SMALL SIZE CABLE ARE EASY TO STORE AND CARRY ON BICYCLE. THEY OFFER GREAT WEIGHT TO STRENGTH RATIO. MOSTLY COLOURFUL LOCKS AIMED FOR CITY RIDERS.



JOLLY
black

JOLLY
red

JOLLY
blue-violet

JOLLY
lime

JOLLY

CABLE LOCK COVERED BY SOFT RUBBER



BILL

SPIRAL CABLE LOCK



CABLE

EXTENSION CABLE

Extends U-Lock's protection to all part of bike



CODECASE

WIRE POCKET LOCK





MISSION:

THE IRREPLACEABLE COMPANION

KLS

ALBE





MAYA

TRIANGLE MTB EXPEDITION BAG

Made of 600D polyester/ 1200D Nylon/ Tarpaulin
Adjustable velcro strap fastening
Expandable thanks to simple zip
VOLUME: 2,8 - 3,8L



AURA

MTB HANDLEBAR EXPEDITION BAG

Made of 600D polyester/Nylon 1200D
Waterproof insert easy to take out
3M reflective stripe
Attachments for other possible accessories
Velcro strap attachment fits all types of handlebars
VOLUME: 9L
DIMENSIONS: 66cm x 37cm x 10cm



TANAYA

REAR MTB EXPEDITION BAG

Made of 600D polyester/Nylon 210D
Water resistant materials keeps your goods dry
3M reflective stripe
Velcro strap attachment fits all seat posts
Side pockets with quick access
Rubber straps can carry extra load
VOLUME: 7L
DIMENSIONS: 57cm x 17cm x 20cm



ADVENTURE 40

REAR PANNIER BAG

Made of 600D polyester/Poly honeycomb/Nylon 210D
 Two main compartments with two side pockets
 Two rear zipped pockets
 3M reflective piping
 Fastening on rear carrier by straps and hooks
 Waterproof raincover in lime colour with taped seams included in bottom pocket.

VOLUME: 40L

DIMMENSIONS: 32cm x 20cm x 40cm (one side)



ADVENTURE 20

REAR PANNIER BAG

Made of 600D polyester/Poly honeycomb/Nylon 210D
 Two main compartments with two smaller side pockets
 Rubber band on the top of the bag
 3M reflective piping
 Fastening on rear carrier by straps and hooks

VOLUME: 20L

DIMMENSIONS: 33cm x 10cm x 28cm (one side)



SPACE 15

REAR PANNIER BAG

Made of 600D polyester/Poly honeycomb/Nylon 210D
 Extendable 2 side pockets
 Inside mesh pocket
 Rubber band on the top of the bag
 3M reflective piping
 Safety light attachment
 Velcro strap fastening
 Detachable shoulder strap

VOLUME: 15L

DIMMENSIONS: 32,5cm x 28cm x 19cm



SPACE 12

REAR PANNIER BAG

Made of 600D polyester
Two side pockets
Reflective piping on the side and back
Safety light attachment
Velcro strap fastening

VOLUME: 12L

DIMENSIONS: 30cm x 18cm x 23cm



SPACE 10

REAR PANNIER BAG

Made of 600D polyester/Poly honeycomb/PVC leather/Nylon 210D
Two side pockets
Inside mesh pocket
Rubber band on the top of the bag
3M reflective piping
Safety light attachment
Velcro strap fastening
Detachable shoulder strap

VOLUME: 10L

DIMENSIONS: 35cm x 18cm x 22cm



BROKER

MESSENGER TYPE PANNIER BAG

Made of 600D polyester/Nylon 210D
Suitable for use for the left side of the of the rear carrier
Main compartment includes laptop pocket (13inch) and two organising pockets
Front pocket for easy access goods
Fastening on rear carrier by straps and hooks
Detachable shoulder strap
Hideable hooks when wearing the bag over shoulder/cross-body

VOLUME: 10L

DIMENSIONS: 35cm x 28m x 10cm



SPACE CITY

REAR PANNIER BAG

- Made of 600D polyester/Nylon 210D
- Two side pockets
- Inside mesh pocket
- Adjustable inside sections
- 3M reflective piping
- Safety light attachment
- Velcro strap fastening
- Carrying strap

VOLUME: 10L

DIMENSIONS: 31cm x 16cm x 20cm



SATELLITE

SEAT POST BAG

- Made of EVA foam/600D polyester/Poly honeycomb
- Inside section can be divided to two parts
- Zippered mesh pocket
- 3M reflective piping
- Safety light attachment
- Quick release system fits all sizes
- Maximum carrying load: 4kg

VOLUME: 3,2L

DIMENSIONS: 31cm x 16cm x 15cm



LEAD

HANDLEBAR BAG

- Made of 600D polyester/Poly honeycomb/PVC leather/Nylon 210D
- Top transparent pocket for map or smartphone
- 2 mesh pockets and one front pocket
- 3M reflective piping
- Shoulder strap included
- Safety light attachment
- Quick release system fits oversized handlebars

VOLUME: 4L

DIMENSIONS: 25,5cm x 14,5cm x 12cm



TRIANGLE

FRAME BAG

Made of 600D polyester 3M reflective piping
Inner compartment with small mesh pocket
Velcro strap fastening
VOLUME: small size 1L, large size 2,5L

WEDGE

FRAME BAG

Made of 600D polyester/ Poly honeycomb/
Nylon 210D
3M reflective piping
Velcro strap fastening
VOLUME: 1,3L
DIMMENSIONS: 12cm x 27cm x 5cm
COLORS: black, blue, lime

RECTANGLE

FRAME BAG

Made of 600D polyester/
Poly honeycomb/Nylon 210D
3M reflective piping
Inner compartment
with small mesh pocket
Adjustable Velcro strap fastening
VOLUME: 0,9L



CHALLENGER

SADDLE BAG

Made of 600D polyester/Poly honeycomb/Tarpaulin
3M reflective stripe
Safety light attachment
Patented T-system toolfree attachment/Velcro strap attachment
SIZES:

CHALLENGER T-SYSTEM/STRAP S
volume 0,4l, dimensions (17cm x 7cm x 8,5cm)
CHALLENGER T-SYSTEM/STRAP M
volume 0,6l (19cm x 8cm x 9,5cm)
CHALLENGER T-SYSTEM/STRAP L
volume 0,9l (21,5cm x 9,5cm x 9,5cm)



T- system TOOLFREE

KLS COBY - 100% water-proof dropper post friendly saddlebag. Made of durable and water-proof PVC-coated material with glued seams, KLS COBY protects precious cycling essentials against water and dirt. Velcro One-Wrap fastening strap allows tool-free and secure fitment to the seat rails. Roll-top closure allows easy access, flexibility and secure sealing of the bag interior.

COBY

SADDLE BAG

Made of PVC material
Suitable also for telescopic seatposts
Water-resistant textile and zipper
Velcro fastening strap
VOLUME: 0,4l
DIMMENSIONS: 12,5cm x 6cm x 5cm



ALPHA

TOP TUBE BAG

Made of 600D polyester/Poly honeycomb/Nylon 210D
Two side pockets with small inner section
Transparent top part keep smartphone up to 5,5 inch display
3M reflective piping
Velcro strap fastening
VOLUME: 0,9L
DIMENSIONS: 14,5cm x 13cm x 11cm



CELLY

TOP TUBE BAG

Made of 600D polyester/ Poly honeycomb/Nylon 210D
Transparent top part keep smartphone up to 5,5 inch display
3M reflective piping
Velcro strap fastening
VOLUME: 0,7L
DIMENSIONS: 10cm x 18cm x 9cm



RAIL

TOP TUBE BAG

Made of 600D polyester
Two side pockets
Reflective piping
Velcro strap fastening
VOLUME: 1,7L
DIMENSIONS: 21cm x 12cm x 4cm (one side)



BRICK

TOP TUBE BAG

Made of 600D polyester
Transparent top part keep smartphone up to 5,5 inch display
Reflective piping
Velcro strap fastening
VOLUME: 1,1L
DIMENSIONS: 19cm x 9cm x 7cm

NAVIGATOR

UNIVERSAL SMART PHONE OR GPS HOLDER BRACKET

Softly padded for protecting phone surface
Bracket could be 360 degrees rotated
Tool less installation or removal
Extendable Arms can hold devices with the size up to 95mm*185mm





CARGO

FRONT BASKET

High quality front steel basket
Very handy for shopping
Quick release bracket
Click" bracket, easy to mount, with swing up handle
Fits for handlebars: 22,2mm - 25,4mm- 31.8mm
SIZE: 340x250x250mm
Carries up to 5kg

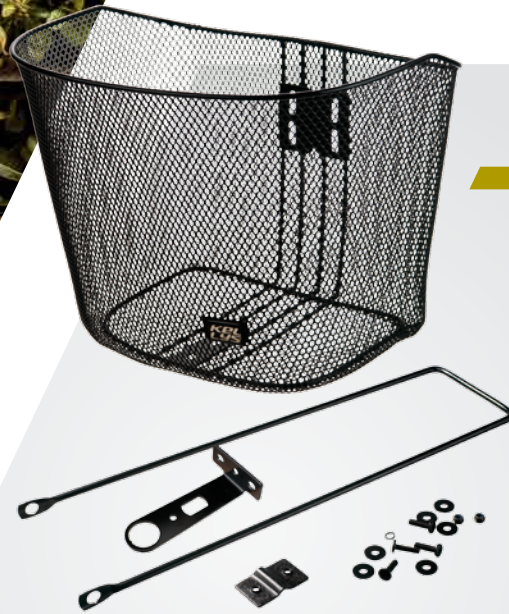

CITY FRONT

FRONT BASKET

front steel basket with brace and grip under the headset nut
Easy to mount
SIZE: 350x255x260mm (W x L x H)
Carries up to 5kg

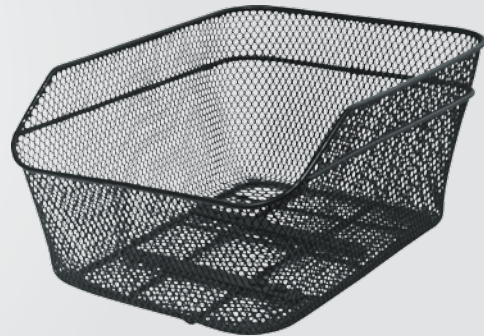

CITY REAR

REAR BASKET

Black steel basket
Fixed mounting lengthwise on luggage carrier (including fixing material)
SIZE: 290x400x180mm
Carries up to 5kg



RATTAN FRONT

FRONT BASKET

High quality plastic rattan basket with brace and grip under the headset nut
Easy to mount
SIZE: 350x260x250mm (W x L x H)
Carries up to 5kg



RATTAN REAR

REAR BASKET

High quality plastic rattan basket
Mounting with cable ties (including 6Pcs)
SIZE: 300x410x190mm
Carries up to 5kg



LOAD REAR

REAR BASKET

High quality plastic basket
Mounting with cable ties (including 6Pcs)
SIZE: 30x41x19cm
Carries up to 5kg

LOAD FRONT

FRONT BASKET

High quality plastic basket with brace and grip under the headset nut
Easy to mount
SIZE: 35x26x25cm
Carries up to 5kg





BUNGEE

STRAP

Double banded elastic bike strap with hooks
Keeps your cargo tight on your bike rack

CONVOY

BICYCLE RACK

For MTB / Cross (26 – 29") bikes
Material aluminum alloy
Suitable for disc and V-brakes
Max load 25kg
With spring
Bracket for lights or reflector



PORTER

BICYCLE RACK

Ø25,4 – 32mm
Quick release TOOLFREE bracket
Material aluminum alloy
Rubber pad for a better grip and seat post protection
Max load 10kg
Bracket for lights or reflector





DRIZZLE FRONT

MUDGUARD

Front mudguard
Suitable for all types of frame tubes
Simple mounting on headtube
Fits 27,5"-29" wheel size

DRIZZLE REAR

MUDGUARD

Rear mudguard
Mudguard holder with an adjustable angle
Simple mounting on all seatpost diameters
Fits 27,5"-29" wheel size



THUNDER

MUDGUARD SET

front and rear mudguard
rear mudguard holder with two joints and an adjustable angle
simple and quick mounting



FUSE

MUDGUARD SET

front and rear mudguard including two clamp diameters for all frame types
adjustable rear mudguard holder



KNIGHT

MUDGUARD SET

front and rear mudguard
front mudguard with Turner system - Two position quick release system
rear mudguard with SQR System - Smart Quick Release System.
QR system for all seat posts diameters
rear mudguard holder with two joints and an adjustable angle





STORM

MUDGUARD SET

Front and rear mudguard for MTB and Cross
Two ways of mounting on the seat tube:
1. Fixation by adjustable mudguard bracket
2. Fixation by flexible mounting strap
Suitable for all frame types



GUARD

MUDGUARD SET

Front and rear mudguard for MTB and Cross
Increased protection for front derailleur
Excellent protection on wet or muddy terrain



RAINY

MUDGUARD SET

Front and rear mudguard for Cross and
Trekking bikes with metal stays
Excellent protection on wet or muddy terrain
Fixation material included
Easy to fit
COLOR: black



WET

MUDGUARD SET

Front and rear mudguard set for
MTB
Fixation material included
Easy to fit, metal stay for increased
stability of rear mudguard
Suitable for disc brakes thanks to
special washer
Fits 29" wheel size



FOGGY

MUDGUARD SET

Front and rear mudguard for children bikes
Suitable for 20" wheels
Fixation material included
Easy to fit
COLORS: black-grey, black-green, black-blue, white-pink, white-grey



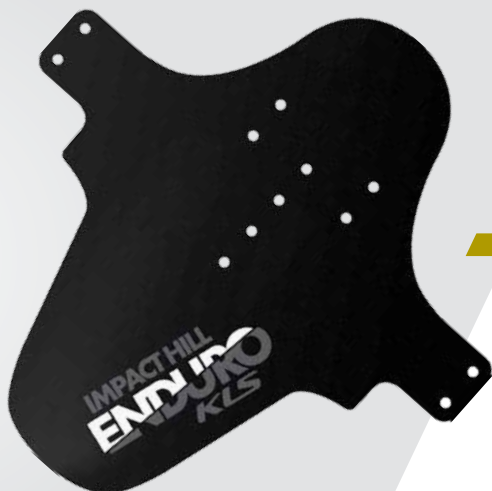

IMPACT HILL

MUDGUARD

Universal FRONT or REAR mudguard with pre-cut holes for cable ties

FRONT mudguard stopping the mud and dirt that's thrown into your eyes from the front wheel, also give additional protection to your fork seals.

REAR mudguard protecting your suspension system (linkages, bearings, joints) and shock from getting dirty

Suitable for forks from 80mm to 200mm travel, fits 26", 27,5" and 29" wheel size.

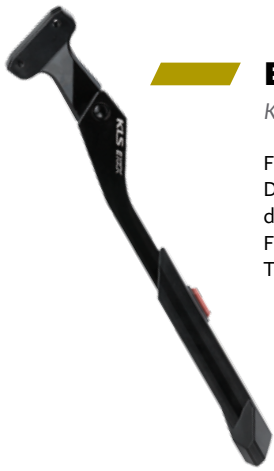

E-KICK
KICKSTAND

For City / MTB / Cross (24" - 29") E-bikes
Directly mounted on the frame - hole distance 40mm
For rear seat stay
TOOLFREE adjustable



DOUBLEKICK
KICKSTAND

For City / MTB / Cross (24 - 28") bikes
Two legs for increased stability
Rubber pads for a better grip and frame protection
INBUS adjustable



KICKDOWN
KICKSTAND

For City / MTB / Cross (24"-29") bikes
Plastic pads for a better grip and frame protection
TOOLFREE adjustable

KICKFLIP
KICKSTAND

For City / MTB / Cross (24 - 28") bikes
For chain stays with fixed plate (40mm width of holes)
Rubber pads for a better grip and frame protection
TOOLFREE adjustable



KICKUP
KICKSTAND

For City / MTB / Cross (24 - 29") bikes
Rubber pads for a better grip and frame protection
TOOLFREE adjustable



KICKBACK
KICKSTAND

for City / MTB / Cross (24"-29") bikes
rubber pads for a better grip and frame protection
tool free adjustable

KICKER
KICKSTAND

For MTB / Cross (26 - 28") bikes
Rubber pads for a better grip and frame protection
TOOLFREE adjustable



KICKSTART
KICKSTAND

For Junior / City (14"-20") bikes
Rubber pads for a better grip and frame protection
TOOLFREE adjustable





SENTRY

CHAIN STAY PROTECTOR

Flexible 3mm thick neoprene cover to prevent chain stay damage
Velcro strap for easy installation

SIZE: M (280 x 110 mm)

COLORS: black

SIZE: L (280 x 130 mm)

COLOR: black



BANG 10

Lightweight bicycle bell with extra loud stainless top and steel spring
Easy to install and remove
Mountable in various positions
360 degrees turnable
With metric screw
COLORS: black, silver, red, blue



BANG 50

Lightweight bicycle mini bell with shrill sound
Easy to install and remove
Mountable in various positions
360 degree turnable
With metric screw
Top size: 23mm
COLORS: gold, black



BANG 30

Lightweight bicycle bell
Alloy top with plastic base and lever
Quick release – easy to install and remove
Top size: 32mm
COLOR: black



BANG 70

High end brass bell with resonant sound
Easy to install and remove
With metric screws
Top size: 50mm
COLORS: brass



BELL 20

Lightweight bicycle bell with ringing sound
Alloy top with plastic base and lever
Easy to install and remove
With metric screw
Top size: 53mm
COLORS: black, silver



BELL 60

Big bicycle bell with ding dong sound
Steel top and base
Easy to install and remove
With metric screws
Top size: 60mm
COLORS: gold, silver, red lips, white flowers



BELL 80

Big bicycle bell with ding dong sound
Steel top and base
Easy to install and remove
With metric screws
Top size: 80mm
COLORS: red dots, black dots, colorful dots, silver



BELL 60 KIDS

BIG BICYCLE BELL AIMED FOR CHILDREN

Easy to install and remove
With metric screws
Top size: 60mm
COLORS: red, blue



BELL 60 DOODLES

BIG BICYCLE BELL WITH DING DONG SOUND

Steel top and base
Easy to install and remove
With metric screws
Top size: 60mm
COLORS: pink, blue, green



BACKSIGHT

BIKE MIRROR

Extended observation angle due to wide slightly convex mirror
Fibre plastic arm for improved break resistance
Aluminium clamp for tight fixation on handlebars
Weatherproof design
Fits on 22mm handlebar
COLOR: Black



SLIPSTREAM

ROAD SADDLE

Longitudinally waved shape for the ultimate long-distance performance.

Raised rear end ensures stability and enhanced support across the entire spectrum of riding positions.

Arched cross-section for full contact with reduced pressure for all-day comfort.

Durable grippy cover for top performance and control.

SIZE: 279 x 145mm

COLOR: Black



FLUO

SADDLE

Saddle made for your daily training

Sport design combined with extra comfort

Hi-Density foam

Scale for precise adjustment

SIZE: 270 x 125mm

COLORS: Red, Green, Blue, Orange, Grey



STYX

SADDLE

Designed specially for Enduro Adventures

Central opening releases pressure in most sensitive area

Hi-Density foam

Scale for precise adjustment

SIZE: 277 x 162mm

COLORS: Red, Green, Blue, Yellow, Orange, Black

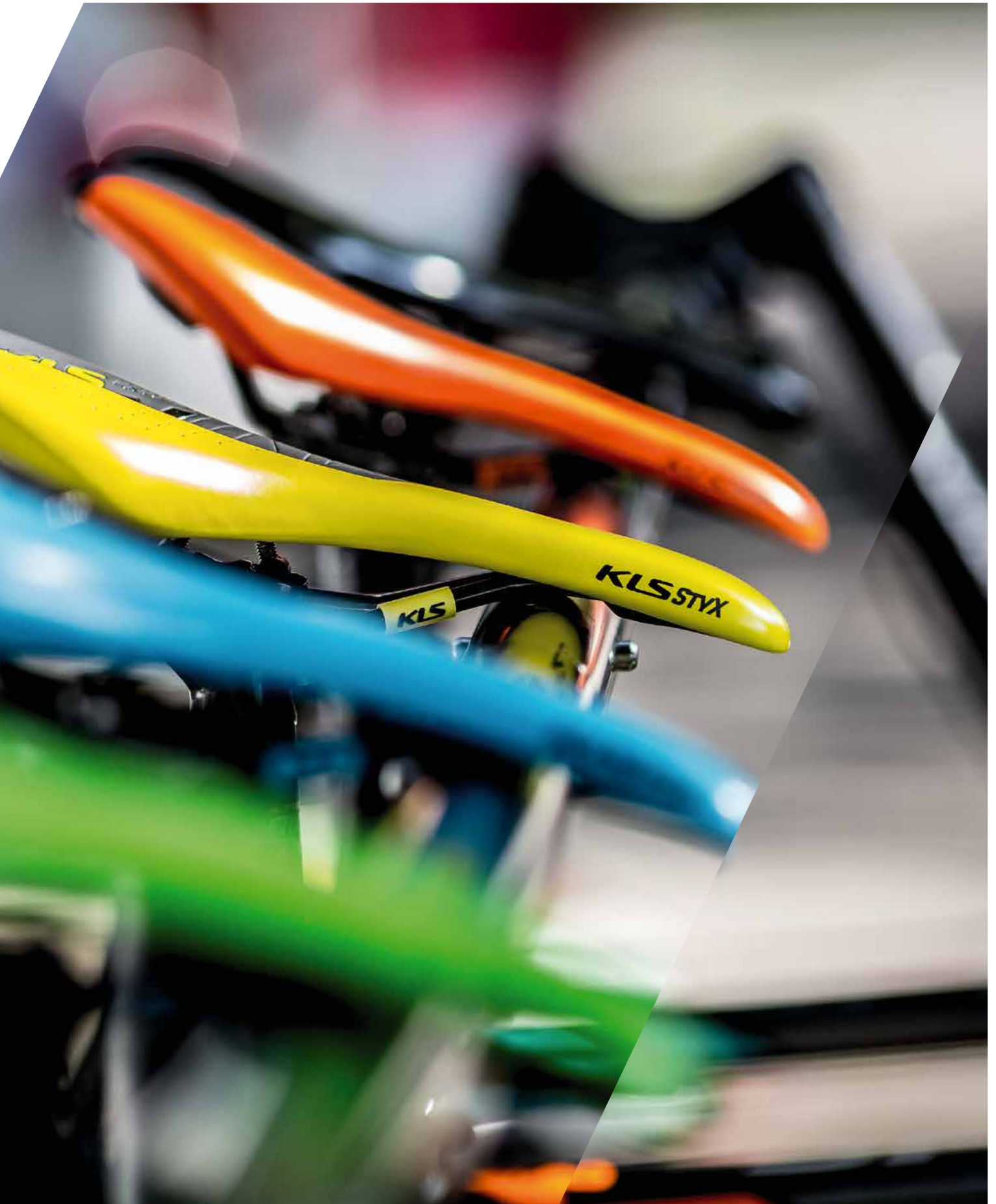



KICKSTARTER

MTB SADDLE

Designed for daily MTB adventures
EVA foam ensures 100% water tightness
Scale for precise adjustment

SIZE: 266 x 157mm

COLORS: Black



DIVERSA

SADDLE

Designed to perfectly fit woman ergonomics
For everyday bike ride anywhere
Hole releases pressure in most sensitive area
Hi-Density foam

Scale for precise adjustment

SIZE: 274 x 158mm

COLORS: Black, White



DRIVELINE

SADDLE

Designed for daily MTB adventures
Zone cut releases pressure in most sensitive area
Hi-Density foam
Scale for precise adjustment
SIZE: 277 x 162mm
COLORS: Red, Green, Blue, Orange, Black



TIMBER

SADDLE

Gel combined with Hi-Density foam
Side protection ensures longer durability
Scale for precise adjustment
For everyday bike ride anywhere
SIZE: 275 x 163mm
COLOR: Black



SOFTLINE

SADDLE

Gel combined with high density foam
Side protection ensures longer durability
Scale for precise adjustment
For everyday bike ride anywhere
SIZE: 257 x 187mm
COLOR: Black

CROSSLINE

SADDLE

Designed for Cross-Country adventures
Side protection ensures longer durability
Zone cut releases pressure in most sensitive area
Hi-Density foam
Scale for precise adjustment
SIZE: 283 x 172mm
COLORS: Red, Green, Blue, Orange, Black



COMFORTLINE

SADDLE

Made to ensure maximum comfort
Zone cut releases pressure in most sensitive area
Hi-Density foam
Scale for precise adjustment
SIZE: 262 x 191mm
COLORS: Red, Green, Blue, Orange, Black



TREKKINGLINE

TREKKING SADDLE

Made to ensure maximum comfort
Zone cut releases pressure in most sensitive area
Hi-Density foam
Scale for precise adjustment
SIZE: 265 x 200mm
COLOR: Black



VAN KELLYS

SADDLE

High density foam
Steel spring for comfort suspension
Scale for precise adjustment
Designed to cruise your city
SIZE: 250 x 210mm
COLORS: Brown, Black



HARLEQUIN

CITY SADDLE

Designed to cruise the Urban area
Double spring coil for a smoothest ride
Zone cut releases pressure in most sensitive area
Scale for precise adjustment
SIZE: 265 x 255 mm
COLORS: Black, Brown



CITYRIDE

SADDLE

Gel combined with high density foam
Elastomer shock absorber system
Scale for precise adjustment
Designed for everyday urban ride
SIZE: 260 x 225mm
COLORS: Black, Brown



EMMA

JUNIOR SADDLE

Designed for everyday bike ride anywhere
 Handle for easy pick up of the bike
 Hi-Density foam
 Scale for precise adjustment
SIZE: 245 x 145 mm
COLORS: Pink, Purple, Turquoise, White



DRIVELINE JUNIOR

SADDLE

Designed for everyday bike ride anywhere
 Made to ensure maximum comfort
 Hi-Density foam
 Scale for precise adjustment
SIZE: 275 x 163mm
COLOR: Grey



WASPER

JUNIOR SADDLE

Designed for everyday bike ride anywhere
 Handle for easy pick up of the bike
 Hi-Density foam
 Scale for precise adjustment
SIZE: 245 x 145 mm
COLORS: Blue, Green, Grey, Red, Yellow



DH 70

HANDLEBAR, RISEBAR

Rise: 1"
Back sweep: 9° / Up sweep: 5°
WIDTH: 810mm
DIAMETER: 31.8mm O/S
FINISH: sand blasted black



ALM/EN 80

HANDLEBAR, RISEBAR

Rise: 18/35mm
Back sweep: 9° / Up sweep: 5°
WIDTH: 780mm
DIAMETER: 35mm
FINISH: sand blasted black



ALM/EN 70

HANDLEBAR, RISEBAR/FLATBAR

Rise 0,5" / 1" / 1,5" / 2"
Back sweep: 9° / Up sweep: 5°
WIDTH: 780mm
DIAMETER: 31.8mm O/S
FINISH: sand blasted black



ULTIMATE XC 70

HANDLEBAR, RISEBAR/FLATBAR

Rise: 0/15mm

Back sweep: 5° / Up sweep: 4°

WIDTH: 720mm

DIAMETER: 31.8mm O/S

FINISH: sand blasted black



ADVANCED XC 70

HANDLEBAR, RISEBAR/FLATBAR

Rise: 0/15mm

Back sweep: 5° / Up sweep: 4°

WIDTH: 720mm

DIAMETER: 31.8mm O/S

FINISH: sand blasted black



ACTIVE XC 70

HANDLEBAR, RISEBAR/FLATBAR

Rise: 0/15mm

Back sweep: 5° / Up sweep: 4°

WIDTH: 720mm

DIAMETER: 31.8mm O/S

FINISH: sand blasted black



CRX 70

HANDLEBAR, RISEBAR

Rise: 15mm

Back sweep: 5° / Up sweep: 4°

WIDTH: 640mm

DIAMETER: 31.8mm O/S

FINISH: sand blasted black



CRX 50

HANDLEBAR, RISEBAR

Rise: 30mm

Back sweep: 9° / Up sweep: 0°

WIDTH: 640mm

DIAMETER: 25.4mm

FINISH: sand blasted black





ALM/EN 70

STEM

ANGLE: 0°
DIAMETER: 31.8mm, 35mm
EXTENSION: 35mm
STEERER TUBE DIAMETER: 28.6mm
FINISH: sand blasted black



ALM/EN 50

STEM

ANGLE: +/- 6°
DIAMETER: 31.8mm O/S
EXTENSION: 35, 45, 60mm
STEERER TUBE DIAMETER: 28.6mm
FINISH: sand blasted black



ULTIMATE XC 70

STEM

ANGLE: 7°
DIAMETER: 31.8mm O/S
EXTENSION: 60, 70, 80, 90, 100, 110, 120, 130mm
STEERER TUBE DIAMETER: 28.6mm
FINISH: sand blasted black



ACTIVE XC 70

STEM

ANGLE: 7°
DIAMETER: 31.8mm O/S
EXTENSION: 60, 70, 80, 90, 100, 110, 120, 130mm
STEERER TUBE DIAMETER: 28.6mm
FINISH: sand blasted black



ADVANCED XC 70

STEM

ANGLE: 7°
DIAMETER: 31.8mm O/S
EXTENSION: 80, 90, 100, 110, 120, 130mm
STEERER TUBE DIAMETER: 28.6mm
FINISH: sand blasted black



CRX 70

STEM

ANGLE: 0 -- +/-60°
DIAMETER: 31.8mm (95, 110, 125mm)
DIAMETER: 25.4mm (90, 110, 125mm)
STEERER TUBE DIAMETER: 28.6mm
FINISH: sand blasted black



CRX 50 QUILL

STEM

ANGLE: 5-55°
DIAMETER: 25.4mm
EXTENSION: 100mm
QUILL LENGTH: 180mm
STEERER TUBE DIAMETER: 22,2mm
FINISH: sand blasted black

ADVANCED XC 70

SEAT POST

Forged head

DIAMETER: 27.2, 30.9, 31.6mm

LENGTH: 400mm

FINISH: sand blasted black



ULTIMATE XC 70

SEAT POST

One-piece aluminum head

DIAMETER: 27.2, 30.9, 31.6mm

LENGTH: 400mm

FINISH: sand blasted black



ACTIVE XC 70

SEAT POST

Die casted clamps

DIAMETER: 27.2, 30.9, 31.6mm

LENGTH: 400mm

FINISH: sand blasted black



CRX/URB 70 S

SEAT POST

Suspended Seat Post

Forged head

DIAMETER: 27.2, 31.6mm

LENGTH: 350mm

FINISH: sand blasted black



CRX/URB 30

SEAT POST

DIAMETER: 27.2, 30.9mm

LENGTH: 400mm

FINISH: sand blasted black,
natural silver



AL 7050 – Strongest aluminum alloy, commonly used in rock-climbing equipment, hang glider frames, military, automotive and, of course, bicycle industry. Toughest material, but difficult to weld. That's why it is used mostly for Handle Bars only.



AL 6061 – Aluminum alloy commonly used in home build or hobby aircraft, yacht constructions or scuba tanks. Provides very good ratio between strength and affordability.



DOUBLE BUTTED – 2 thicknesses of material are combined to provide best of both – strength and lightweight. Where the material needs to stand against strong pressure, it is thickened to provide extra strength. On points where the material is not handling that much pressure, it is thinned to reduce unnecessary weight.



T6 – process of increasing the material hardness by heating the material to a certain temperature for certain period of time. Times and temperatures may vary based on materials used. This process arranges atoms in molecular structures which greatly increase the strength of material. Also called "Aging Process"



3D FORGING – Solid block of heated aluminum is compressed into desired mould. Advantage of this technology of forging is that no welding needs to be used, so the component is lighter and stronger in the end.



POISON

GRIPS

2 alloy lock rings for slip-free performance and easy mounting
Extra soft materials for extra comfort
Rough design for tight grip and ultimate ride control
Plastic plugs included

WIDTH: 135mm

COLORS: Red, Green, Blue, Yellow, Orange, White, Black



TOKEN

GRIPS

Semi ergo shape
Combines comfort of ergo grip yet can handle rough MTB terrain
Single-lockring version for slip-free performance and easy mounting available
2 density kraton rubber for soft touch and shock absorption

WIDTH: 135mm

COLORS: Red, Green, Blue, Turquoise, Purple, Yellow, Orange, White, Black





SILICA

GRIPS

Silicone grips made for absolute comfort
Excellent performance – wet or dry

WIDTH: 130mm

OUTER DIAMETER: Ø34mm

COLORS: Red, Green, Blue, Turquoise, Purple, Yellow, Orange, White



ADVANCER

GRIPS

2 density kraton rubber for soft touch and shock absorption
Designed for tight grip and ultimate drive control

WIDTH: 130mm

COLORS: Red, Green, Blue, Turquoise, Purple, Yellow, Orange, White, Black



CRYPTON

GRIPS

Single LockOn for slip-free performance and easy mounting
2 density kraton rubber for soft touch and shock absorption
Designed for tight grip and ultimate ride control

WIDTH: 135mm

COLORS: Red, Green, Blue, Yellow, Orange, White, Black

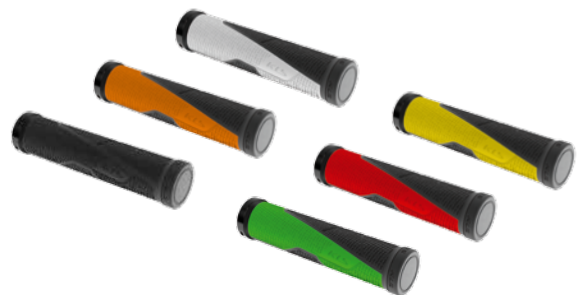

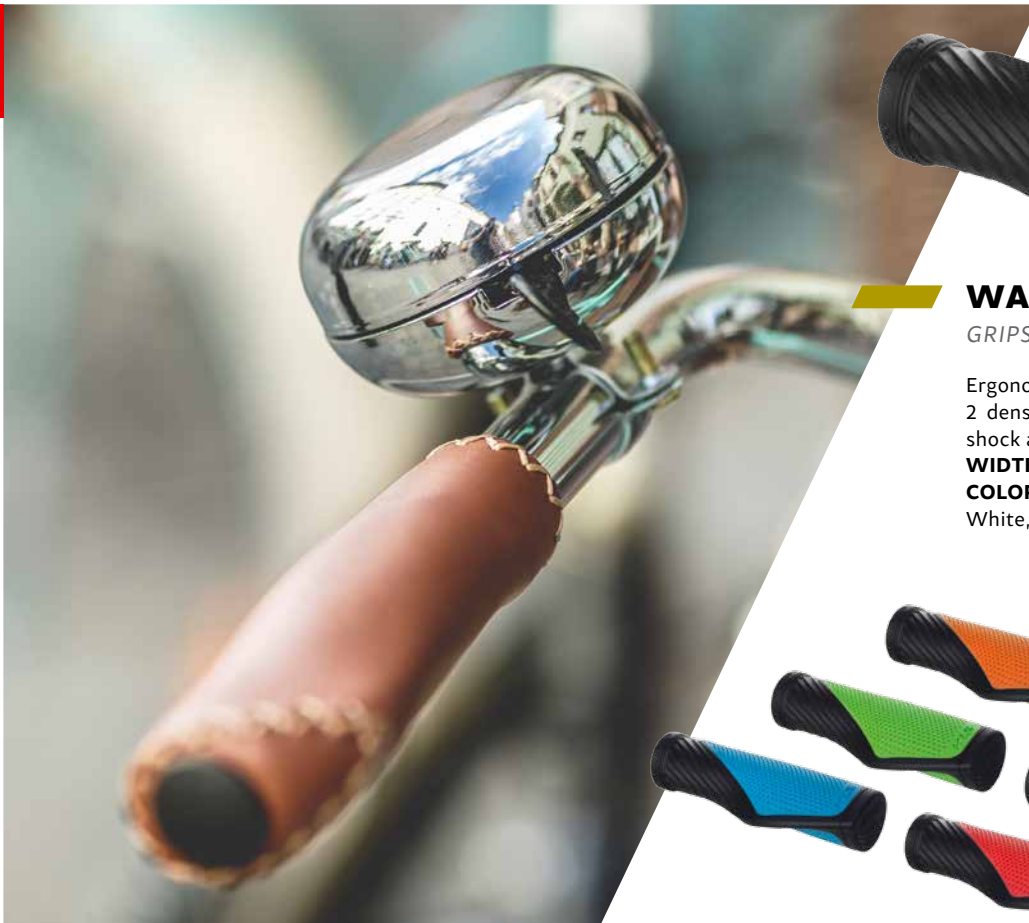

WAVE

GRIPS

Ergonomic shape ensure maximum comfort
2 density kraton rubber for soft touch and shock absorption

WIDTH: 135mm

COLORS: Red, Green, Blue, Yellow, Orange, White, Black



KIDDO'

GRIPS

Slip protection helps your youngest to keep hands on handlebars at all times
Designed to fall in love with instantly

WIDTH: 95mm

COLORS: Red, Green, Blue, Yellow, Pink, Purple, White, Black



HOLLANDGRIP

GRIPS

Ergonomic Shape
Designed for stylish ride through your city
Provides excellent grip with optimal control

WIDTH: 132, 132/92 mm

COLORS: Brown, Black



SHORTGRIP

GRIPS

Kraton rubber absorbs vibration
Designed for Twist-Grip systems

WIDTH: 90mm

COLOR: Black



BASTOGNE

HANDLEBAR TAPE

Microfiber with EVA base with VexGel™ adhesive for ultimate vibration absorption and durability
 Diamond pattern for enhanced grip even without gloves
 Easy cleaning surface
 End-plugs, short stripes and flexible finishing tapes included
COLORS: Black, Blue, Red, White



TRENTO

HANDLEBAR TAPE

Durable EVA tape with VexGel™ adhesive ultimate vibration absorption
 Tacky soft touch surface for all-day long comfort
 Easy cleaning surface
 End-plugs, short stripes and flexible finishing tapes included
COLORS: Black, Blue, Jersey rojo red, Maillot jaune yellow, Green, Maglia rosa pink, Neon yellow, Polka dot white



ADVANCED

BAR ENDS

Ergonomic shape
 One piece 6061-T6 aluminum alloy
LENGTH: 110mm
FINISH: Sand Blasted Black



CRX 30

BAR ENDS

Ergonomic shape
 One piece 6061 aluminum alloy
LENGTH: 160mm
FINISH: Sand Blasted Black





CNC
MACHINED
AL6061 CRMo



STEALTH

PEDALS

Platform pedal with a concave body
CNC machined pedal made of 6082 aluminium alloy
Thru Pins
User maintainable
Supplied with 2 full sets of 8mm pins
Body: CNC aluminum
Axle: CNC-machined Cr-Mo
Bearing: Sealed cartridge bearings
SIZE: 105 x 100mm
WEIGHT: 390g



REIN

PEDALS

BMX/MTB platform pedals made of thermoplastic reinforced by fiber glass
Axle: Cr-Mo steel
Bearing: LSL bushing & sealed
Pins: Replaceable grip pins, 2 extra pins included
DIMENSIONS: 100 x 95 x 18mm
WEIGHT: 350g/pair
COLORS: black, yellow, green



MACHINED
CNC
AL6061 CRMo

FLAT 50

PEDALS

Aluminum pedal for BMX/MTB
Pins: Replaceable grip pins and 2 extra pins included.
Axle: CNC-machined Cr-Mo
Body: Die-cast aluminum
Bearing: LSL Bushing & Sealed
SIZE: 115 x 108mm
WEIGHT: 550g
COLORS: Black, Lime, Orange



FLAT 50 BB

PEDALS

Aluminum pedal for BMX/MTB
Pins: Replaceable grip pins and 2 extra pins included.
Axle: Boron steel
Body: Die-cast aluminum
Bearing: Ball bearings
SIZE: 115 x 108mm
WEIGHT: 550g
COLORS: Black, Lime, Orange



CLIP 30

PEDALS

Aluminum SPD Compatible pedal for MTB
One side SPD cleat, stable platform on the other.
Body: Aluminum
Axle: Cr-Mo
Bearing: Sealed
SIZE: 98 x 63mm
WEIGHT: 322g



CLIP 10

PEDALS

Aluminum SPD Compatible pedal for MTB
One side SPD cleat, stable platform on the other.
Body: Aluminum
Axle: Cr-Mo
Bearing: Sealed
SIZE: 103 x 63mm



FLAT 10

PEDALS

Plastic pedal for BMX/City

Body: Plastic

Axle: Boron

Bearing: Ball bearing

SIZE: 110 x 104mm

WEIGHT: 320g

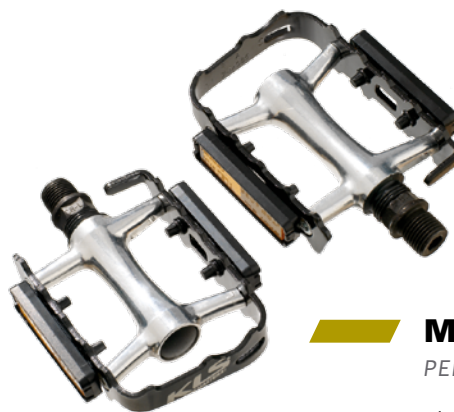

MASTER

PEDALS

Aluminium pedal for MTB/Cross

Body: Aluminium

Axle: Cr-Mo

Bearing: Ball bearing

SIZE: 95 x 78mm

WEIGHT: 264g

TRAIL 30

PEDALS

Aluminium pedal for Cross/City

Body: Aluminium with non-slip rubber surface

Axle: Boron

Bearing: Ball bearings

SIZE: 108 x 84mm

WEIGHT: 390g



TRAIL 10

PEDALS

Plastic pedal for City/Cross

Body: Plastic

Axle: Boron

Bearing: Ball bearing

SIZE: 109 x 75mm

WEIGHT: 384g



ACCESSORIES

SERVICE & CARE





MATE

RATCHET AND BITS HOLDER

MATE is your friend on the trail, helping you with every problem. Durable ratchet with 11 bits for repairs and adjustments on the go. Everything set in the stylish aluminum box.

COLORS: red, black



2mm hex	2.5mm hex	3mm hex	4mm hex	5mm hex	6mm hex
8mm hex	T25 torx	philips head screwdriver		flat head screwdriver	
T10 torx					



ADROIT

FOLDING TOOL

Compact minitool with chain tool
Hardened chromevanadium steel (Cr-V) keys
19-functions, includes:

chain tool with chain hook	tire levers	2mm hex	2.5mm hex	3mm hex
4mm hex	5mm hex	6mm hex	8mm hex	box wrench 8mm
box wrench 9mm	box wrench 10mm		Torx 25	
philips head screwdriver	flat head screwdriver	spoke wrench 3.2 / 3.3 / 3.5mm		

CHAINEY

FOLDING TOOL

Compact minitool with chain tool,
hardened chromevanadium,
steel (CR-V) hex keys
11 functions, includes:

2mm hex	2.5mm hex	3mm hex
4mm hex	5mm hex	6mm hex
8mm hex	T25 torx	chain tool
philips head screwdriver		
flat head screwdriver		





GUIDE

FOLDING TOOL

Compact, lightweight (105,5g) minitool with chain tool
 Hardened chromevanadium steel (CR-V) keys
 15 functions, includes:

chain tool	2.5mm hex	3mm hex	4mm hex	5mm hex
6mm hex	8mm hex	T25 torx	philips head screwdriver	
flat head screwdriver		Spoke wrench 3,2 / 3,3 / 3,4 / 3,9mm		
Mavic spoke wrench				



STINGER 10

FOLDING TOOL

Compact, small minitool, hardened chromevanadium steel (CR-V) hex keys

COLORS: grey, lime
10 functions, includes:

2mm hex	2.5mm hex	3mm hex	4mm hex	5mm hex	6mm hex
8mm hex	T25 torx	philips head screwdriver	flat head screwdriver		



STINGER 8

FOLDING TOOL

Compact, small minitool, hardened chromevanadium steel (CR-V) hex keys
8 functions, includes:

2mm hex	3mm hex	4mm hex	5mm hex	6mm hex	8mm hex
philips head screwdriver		flat head screwdriver			

SPARTAN

15MM PEDAL WRENCH

Ergonomic handle
Manipulation angle for better handling
Hardened chromevanadium steel (Cr-V)
15mm box wrench



HEXCODE

HEXCODE

ALLENKEYS

Hardened chromevanadium steel (Cr-V) keys
With ball ends for up to a 30° angle of rotation
10-hex keys, includes:

1.5mm hex	2mm hex	2.5mm hex
3mm hex	4mm hex	5mm hex
6mm hex	8mm hex	10mm hex





SPIKE

CHAIN TOOL

2 density ergonomic handle
Chain hook, replaceable pin
For IG / HG / UG chains

TRIDENT

ALLENKEYS

Plastic handle
Hardened chrome vanadium
steel (Cr-V) keys

4mm hex

5mm hex

6mm hex



JACK 10

TIRE LEVERS

3 piece set of plastic levers
Large handle provides high leverage,
spoke hook



JACK 90

TIRE LEVERS

Aluminum tyre lever w/Hi-polish finish
Surrounded with the plastic protector to
avoid rim from damage during use.





SERVICE & CARE

CLEANERS & LUBRICANTS

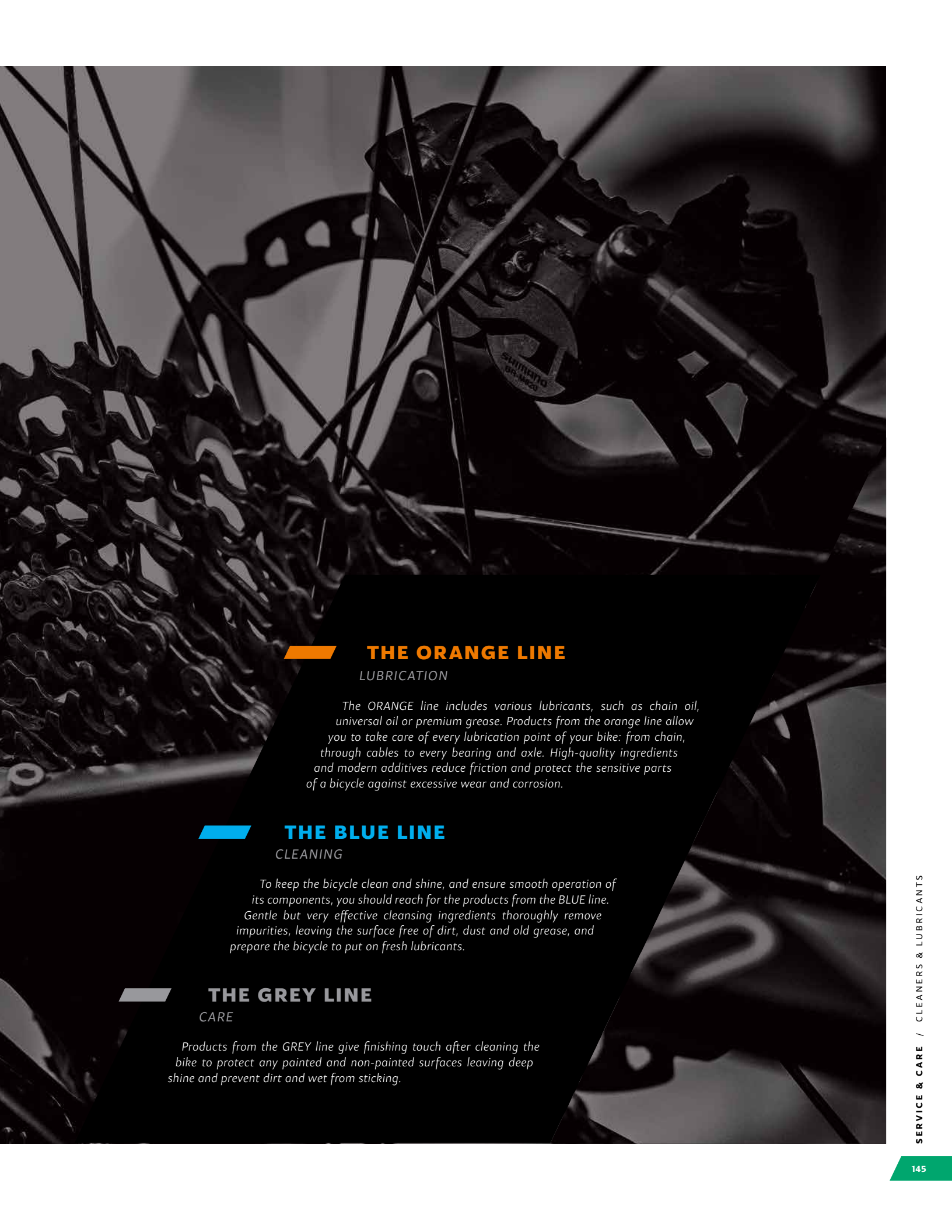

THE ORANGE LINE

LUBRICATION

The ORANGE line includes various lubricants, such as chain oil, universal oil or premium grease. Products from the orange line allow you to take care of every lubrication point of your bike: from chain, through cables to every bearing and axle. High-quality ingredients and modern additives reduce friction and protect the sensitive parts of a bicycle against excessive wear and corrosion.

THE BLUE LINE

CLEANING

To keep the bicycle clean and shine, and ensure smooth operation of its components, you should reach for the products from the BLUE line. Gentle but very effective cleansing ingredients thoroughly remove impurities, leaving the surface free of dirt, dust and old grease, and prepare the bicycle to put on fresh lubricants.

THE GREY LINE

CARE

Products from the GREY line give finishing touch after cleaning the bike to protect any painted and non-painted surfaces leaving deep shine and prevent dirt and wet from sticking.



SILICONE OIL

Silicone Oil is suitable for oiling and preservation during repairing and maintaining bicycles, particularly shock absorbing forks (do not confuse with oils for filling shock absorbers), O-rings, rubber seals, cables, Bowden cables, and pins in gears or lever-key switches. It may also be used for general oiling.
Spray 200ml



PREMIUM LUBE WHITE

Bike lube „white“ is a highly effective white grease with content of PTFE (polytetrafluoroethylene) useful for the lubrication of slide and roll bearings, hubs, heads, pedals, etc. The lubricant excels in its high resistance against water and provides a long life for all bearings.
Tube 100g



MULTIFUNCTIONAL OIL BIO

Multifunctional Oil BIO is a biodegradable all-purpose fluid suitable for general lubrication, loosening of rusted joints, and prevention of corrosion.
Spray 200ml / Applicator 100ml



CHAIN OIL

As the name suggests, Chain oil is white lubricant for chains. The lubricant flows easily into the open spaces in the chain, lubricates the chain and protects it against rust. It is also suitable for O-ring chains. It doesn't contain excessive adhesive components and is, therefore, better suited for the lubrication of chains on mountain as well as highway bicycles under all types of conditions, from dust to rain.
Spray 200ml / Applicator 50ml



BIKE POLISH

Bike polish is cleaner / degreaser. By simply spraying on the agent it quickly removes grease, oil, dirt and brake fluid. It is suitable for degreasing chains before being lubricated by Chain oil and also degreasing bearings, brake and clutch pads and other metal components.
Spray 200ml



MULTI DEGREASER

„Multi“ degreaser is cleaner / degreaser in one. By simply spraying on the agent it quickly removes grease, oil, dirt and brake fluid. It is suitable for degreasing chains before being lubricated by Chain oil and also degreasing bearings, brake and clutch pads, and other metal components.
Spray 750ml

BIKE CLEANER

Bike Cleaner is a maintenance and cleaning agent for cleaning bicycles from mud and other contamination. Higher foaming ability ensures a lower consumption of the agent. Bike Cleaner is applied by spraying on the contaminated spots (derailleurs, pedals, hubs, frame). It is particularly suitable to clean very contaminated parts (chains, sprockets, etc.) where it adheres due to its foaming ability and thus the product consumption is lower. It does not harm paint.
Applicator 500ml/1000ml





N306PD1

BRAKE LEVERS

Left and right side brake lever set
Lightweight aluminum lever / plastic body
22,2mm Standard clamp diameter
Adjustable reach
Fits all standard straight and riser bars
Suitable for MTB, Cross, Trekking



T210DG4

BRAKE CALIPERS

125 mm Alloy arms (set R + L)
MTB brake shoes 70 mm (included)
Includes noodles, washers and mounting bolts M6
Compatible with all brands of V-brake levers



KLS CONTROLSTOP V-01

CARTRIDGE

PSC - power/safe/control technology – shorter braking distance
All-weather compound
- dry conditions (red compound)
- wet conditions (grey compound)
Antisqueal design
Excellent rim cleaning profile
LENGTH: 72mm



KLS CONTROLSTOP V-02

PSC - power/safe/control technology – shorter braking distance
all-weather compound
- dry conditions (red compound)
- wet conditions (grey compound)
antisqueal design
excellent rim cleaning profile
LENGTH: 72mm

KLS CONTROLSTOP VR-01

replacement brake shoes for KLS CONTROLSTOP V-01



KLS DUALSTOP V-01

CARTRIDGE

all-weather compound
- dry conditions (red compound)
- wet conditions (black compound)
antisqueal design
excellent rim cleaning profile
LENGTH: 72mm



KLS DUALSTOP V-02

all-weather compound
- dry conditions (red compound)
- wet conditions (black compound)
antisqueal design
excellent rim cleaning profile
LENGTH: 72mm



KLS DUALSTOP VR-01

replacement brake shoes for KLS DUALSTOP V-01



KLS POWERSTOP V-01

CARTRIDGE

all conditions medium compound
antisqueal design
LENGTH: 72mm



KLS POWERSTOP VR-01

replacement brake shoes for KLS POWERSTOP V-01

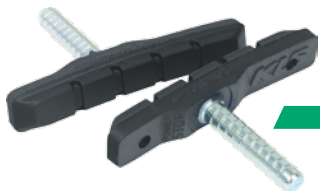

KLS POWERSTOP V-02

all conditions medium compound
antisqueal design
LENGTH: 72mm



KLS POWERSTOP C-02

CANTILEVER

all conditions medium compound
antisqueal design
LENGTH: 72mm



SHIMANO

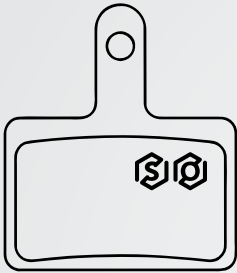

KLS D-04
KLS D-04S

SHIMANO BR-M575, M495, M486, M485, M475, M465, M447, M446, M445, M416, M416A, M415, M395, M375, M365, M355, M315, NEXAVE BR-C601, C501, ALIVIO BR-M4050, ACERA BR-M3050, TOURNEY BR-TX805, DEORE BR-M525, M515, M515LA, LX BR-T675, BR-T615, PROMAX DSK-909, SOLVE, LUCID, E-CAPSULE, F1, GIANT ROOT, TEKTRON ORION 4P×2P, SL, ORION, GIMINI SL, AURIGA, E-COMP, SUB, E-SUB, TUNE, E-TUNE, TWIN, E-TWIN, VOLANS, VELA, DORADO, DRACO, AQUILA, ARIES, MIRA, HDC, PARABOX R, HYLEX, SPYRE, SLC, HY, RD, SLATE X2, DASH SPORT, RST D-POWER, QDH-01, CLARKS S2

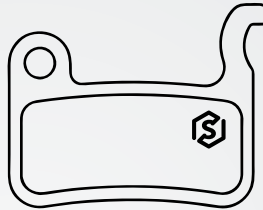

KLS D-03
KLS D-03S

SHIMANO BR-T605, M545, R505, ALFINE BR-S501, S500, XTR BR-M975, M966, M965, SAINT BR-M800, HONE BR-M601, DEORE XT BR-M776, M775, M765, LX BR-T665, M585, BR-M596, M595, M535, SLX BR-M665

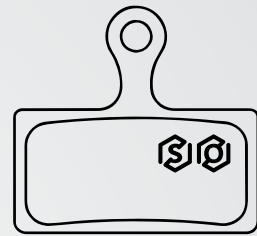

KLS D-14
KLS D-14S

SHIMANO XTR 2011



KLS D-16
KLS D-16S

SHIMANO SAINT 2008 M810, ZEE BR-M640, BR-M820, TRP QUADIEM

AVID

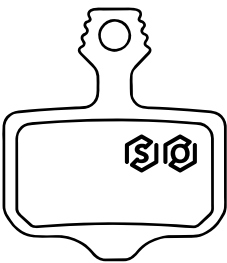

KLS D-01
KLS D-01S

AVID ELIXIR, SRAM XX, SRAM XO SERIES

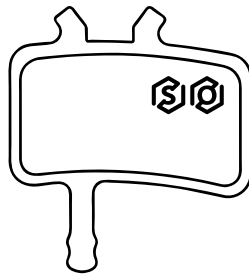

KLS D-02
KLS D-02S

AVID JUICY BB7, JUICY ULTIMATE, PROMAX DSK-950

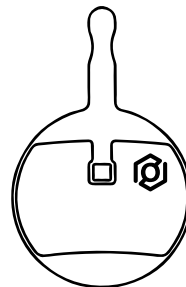

KLS D-15

AVID BB5

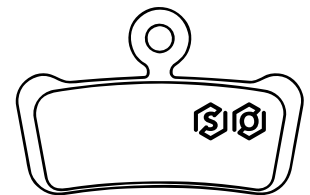

KLS D-17
KLS D-17S

AVID XO TRAIL

HAYES

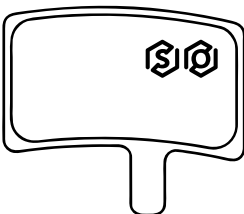

KLS D-05
KLS D-05S

HAYES STROKER TRIAL

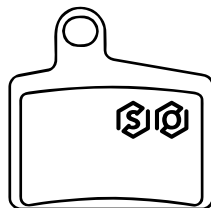

KLS D-06
KLS D-06S

HAYES STROKER RYDE, DYNO

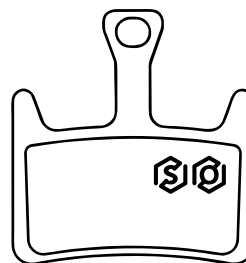

KLS D-07
KLS D-07S

HAYES PRIME



KLS D-08
KLS D-08S

HAYES SOLE HYDRAULIC, MX2, MX3, MX4, GX AND SOLE MECHANICAL



SINTERED METALLIC PAD HIGH FRICTION COMPOUND

Durable for heavy duty use
High working temperature
Consistent braking power and very limited fading during long descends with intensive braking
Excellent performance in wet and muddy condition



ORGANIC RESIN PAD SOFT COMPOUND REINFORCED BY KEVLAR

Quiet
Low working temperature
Higher modulation at the lever
Perfect for daily use in all-weather condition

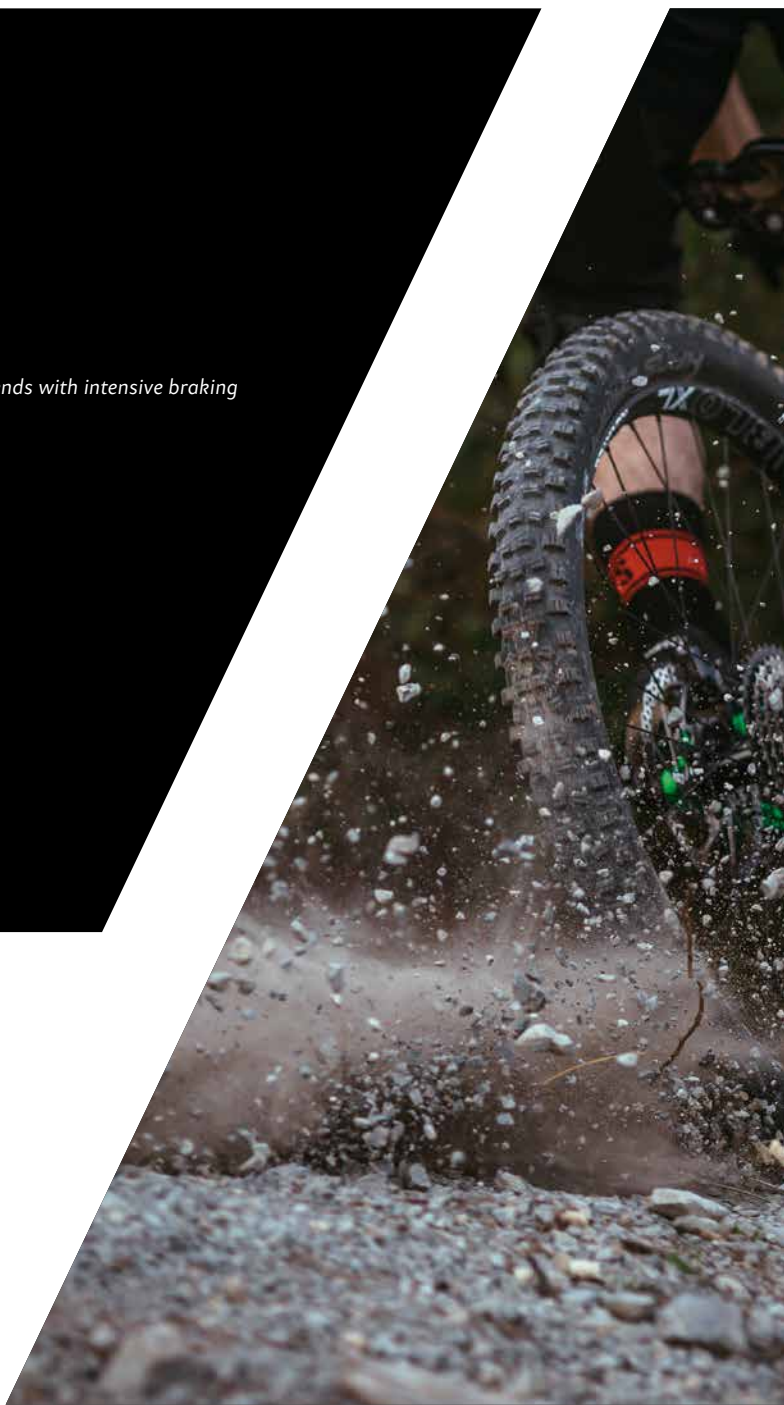

FORMULA

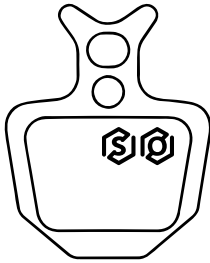

KLS D-09
KLS D-09S

FORMULA ORO

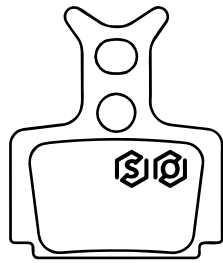

KLS D-10
KLS D-10S

FORMULA MEGA ONE,
R, R1, RX, RC, RO

MAGURA

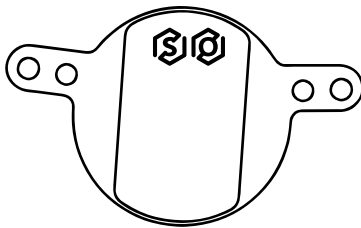

KLS D-12
KLS D-12S

MAGURA JULIE CALIPER
2001-2008

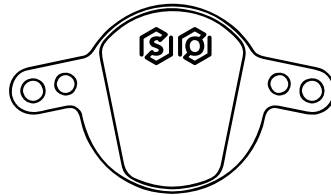

KLS D-11
KLS D-11S

MAGURA CLARA 2001-2002 /
LOUISE 2002-2006 / LOUISE FR

ZOOM



KLS D-13

ZOOM



TUBE REPAIR KIT

show box consist of 50 plastic boxes
 plastic box consist of:
 5ml of glue, 2pcs of 20mm round patches,
 2pcs of 25mm round patches, 2pcs of
 24x35mm rectangle patches, 1pc of sand
 paper, instruction manual



MTB TUBE REPAIR KIT WITH SELF ADHESIVE SQUARE PATCHES

6PCS of Premium quality self-adhesive MTB patches
 in plastic box
 Sandpaper for tube preparation included
 Patch dimensions 25 x 25 mm
 instruction manual

KLS INNER TUBES

high quality butyl inner tubes
 air pressure long-term stability
 excelent resistance against puncture

WHEEL SIZE	ETRTO	INCHES	AV35	AV40	AV40 FT	AV48	AV40 45°	DV40	FV33	FV39	FV48
12 1/2"	57-203	12-1/2x2-1/4		•			•				
16"	47/57 - 305	16 x 1,75-2,0		•							
20"	47/57 - 406	20 x 1,75-2,125		•				•			
24"	47/57 - 507	24 x 1,75-2,125		•				•			
24"	37-540	24x1-3/8		•							
26"	32-559	26x1,25		•							
26"	47/57-559	26x1,75-2,125	•		•	•		•	•		•
26"	37-590	26x1-3/8						•			
27,5"	47/57-584	27,5x1,75-2,125		•	•					•	
27,5"	56/60-584	27,5x2,10-2,40									•
27,5"	584-53/76	27,5x2,5-3,0								•	
28"	18/23-622	700x19-23C	•			•		•	•		•
28"	25/32-622/630	700x25-32C	•			•		•	•		•
28"	35/44-622/630	700x35-43C	•			•		•	•		•
28"	47-622	700x47C			•						•
29"	47/57-622	29x1,75-2,125		•	•					•	
29"	58/62-622	29x2,20-2,50									•

TYRES

NAME	ETRTO	INCHES	TPI	DEDICATED FOR				COLOR		PROTECTION TECHNOLOGY		
				MTB-CROSS COUNTRY	CROSS/TREKING	ROAD	TIRE	BLACK	BLACK/REFLEX	CAP GUARD	LIGHT GUARD	KEVLAR INSIDE
HORIZON	23-622	700XwC	33			•		•				
RADIUS	40-622	700x38C	22		•			•				
	47-622	700x45C	22		•			•				
ELEVATION	47-305	16x1,75	22				•	•				
	54-406	20x1,95	22				•	•				
	47-507	24x1,75	22				•	•				
	47-559	26x1.75	22				•	•				
	47-559	26x1.75	22				•		•			
	50-584	27,5x2.0	22				•	•				
	40-622	700x38c	22		•			•				
	40-622	700x38c	22		•				•			
ATTACK	54-559	26x2.10	33	•				•				
	54-584	27,5x2.10	22	•				•				
	54-584	27,5x2.10	33	•				•				
	54-622	29x2.10	22	•				•				
	54-622	29x2.10	33	•				•				
SUBURBAN	54-559	26x2.0	22	•				•				
	54-559	26x2.0	22	•					•			
SNAKE	56-559	26x2.1	22	•				•				
CROSTOWN	37-540	24x1 3/8	22				•	•				
	37-540	24x1 3/8	22				•		•			
	37-590	26x1 3/8	22				•	•				
	37-590	26x1 3/8	22				•		•			
HORNET	54-406	20x2.0	22				•	•				
	54-507	24x2.0	22				•	•				
PARALAX	47-406	20x2.0	22				•	•				
COUGAR	47-305	16x1.75	22				•	•				
STRIKER	57-203	12 1/2x2 1/4	22				•	•				

TYRES WITH PP PROTECTION

HORIZON	23-622	700X23C	33			•		•		•		
RADIUS	47-622	700x45C	22		•			•		•		
ELEVATION	42-622	700x40C	22		•			•			•	
ATTACK	54-584	27,5x2,1	22	•				•				•
	584-70	27,5x2,8	33	•				•				•
	584-57	27,5x2,25	33	•				•				•
	54-622	29x2,1	22	•				•				•
METROPOLIS	47-559	26x1,75	22				•	•		•		
WASP	47-622	700x45C	22		•			•				•
SUBURBAN	54-559	26x2.0	22	•				•			•	



KMC CHAINS

KMC Chain old name	KMC Chain new name	SPEED	MTB	ROAD	FITNESS/ SINGLE SPEED	BMX, FREESTYLE, E-BIKES FIXIE	SHIMANO COMPATIBLE	SRAM COMPATIBLE
KMCX11	KMC X11	11	•	•			HG600/601	PC1110/PC1130
KMCX11EL	KMC X11EL	11	•	•			HG900/901/HG700/701	PC1170/ RED22
KMC X10EL	KMC X10EL	10	•	•			4601/HG54/HG95	PC1071/PC1051/PC1031
KMC X9	KMC X9	9	•	•			HG93/HG73/HG53	PC991/PC971/PC951
KMC Z7	KMC Z8	8	•	•			HG71/HG40	PC890/870/850/830
KMC Z51	KMC Z7	7	•	•			HG71/HG40	PC10
KMC Z33	KMC Z6	6	•	•			HG71/HG40	PC10
KMC Z510	KMC Z1 Wide	1			•		ALFINE/ NEXUS	AUTOMATIX
KMC Z410	KMC S1	1				•	CN-NX10	PC1/PC7X
KMC e1	KMC e1	1				•		
KMC e10T NPNP	KMC e10T NPNP	10				•	KMC eBike chains is comatable for BOSCH ebike system and other eBike System in the market.	
KMC e11T NPNP	KMC e11T NPNP	11				•		
KMC X12 NPNP	KMC X12 NPNP	12	•	•				XX1 Eagle, X01 Eagle, GX Eagle, NX Eagle

KELLYS BICYCLES IS OFFICIAL KMC DISTRIBUTOR

- Foundation of KMC began in 1977 in Taiwan. Since then, KMC has been concentrating on chain design and production for nearly 40 years.
- KMC sales reach all over the world
- KMC is the world leader in chain manufacturing. Based on its bicycle chain manufacturing technologies, KMC also produces a variety of other chain products, like automobile timing chains, motorcycle chains, and industrial chains.
- KMC invests a lot in their R&D. KMC has broken their past achievement records: the first chain manufacturer to release a Super Lightweight chain, to offer Color chain (including Titanium-Nitride coated chain and Patriot chain), to use Diamond-Like Coating (DLC) reduced-friction technology on the chain, and to achieve the chain industry's first Carbon Footprint assessment certificate to show its commitment to eco-friendly manufacturing.

INNER WIRE - OUTER CASING

INNER WIRE	TEFLON COATED	STAINLESS STEEL	GALVANIZED
GEAR WIRE 210 cm *	•	•	•
BRAKE WIRE MTB+ROAD 180 cm *	•	•	•
GEAR CABLE KIT **		•	•
BRAKE CABLE KIT **		•	•
BIG CABLE KIT ***		•	•
GEAR WIRE 210 cm/100 pcs		•	•
FRONT BRAKE WIRE 100 cm / 100 pcs		•	•
REAR BRAKE WIRE 180 cm / 100 pcs		•	•
GEAR INNER WIRE END CAPS / 100 pcs			
BRAKE INNER WIRE END CAPS / 100 pcs			

OUTER CASING	BLACK	RED	GREEN	SKY BLUE	LIME	YELLOW	ORANGE
GEAR OUTER CASING *	•	•	•	•	•	•	•
BRAKE OUTER CASING *	•	•	•	•	•	•	•
GEAR OUTER CASING / 25m	•	•	•	•	•	•	•
BRAKE OUTER CASING / 25m	•	•	•	•	•	•	•
GEAR OUTER CASING END CAPS / 100 pcs							
BRAKE OUTER CASING END CAPS / 100 pcs							

* END PLUGS INCLUDED

** GEAR AND BRAKE CABLE KITS INCLUDES 2 INNER WIRES, 1 OUTER CASING AND END CAPS

*** BIG CALBE KIT INCLUDES 4 INNER WIRES FOR MTB+ROAD, 2 OUTER CASINGS AND END CAPS



RIM TAPES

Rim Tape	AV	FV
28/29 x 22mm*	•	
28/29 x 16mm*	•	•
27,5 x 22mm*	•	•
26 x 22mm*	•	•
26 x 16mm*	•	
24 x 14mm	•	
20 x 14mm	•	

* Available also in OEM version



BRAVE

RIM

Double-wall rim made especially for Bikeparks
Single eyelet
Brakes: DSC
Holes: 32, 36
Rim tape: 28mm
WIDTH: 23mm
VALVE: FV
SIZES: 26", 27,5"
COLORS: Black



VALOR

RIM

Double-wall rim made for Enduro adventures
Single eyelet
Brakes: DSC
Holes: 32
Rim tape: 25mm
WIDTH: 23mm
VALVE: FV
SIZES: 27,5"
COLORS: Black



BENDER +27,5"

RIM

Double-wall rim made for +sized wheels
Single eyelet
Brakes: DSC
Holes: 32
Rim tape: 22mm
WIDTH: 38mm
VALVE: FV
SIZES: +27,5"
COLORS: Black



CARTEL

RIM

Double-wall rim made for more advanced trails
Brakes: DSC
Holes: 32
Rim tape: 22mm
WIDTH: 21mm
VALVE: FV
SIZES: 27,5", 28/29"
COLORS: Black



MADMAX

RIM

Double-wall rim made for MTB adventures
Single eyelet
Brakes: DSC
Holes: 32
Rim tape: 22mm
WIDTH: 18mm
VALVE: FV
SIZES: 26", 27,5", 28/29"
COLORS: Black



DRAFT

RIM

Universal double-wall rim for everyday use
Single eyelet
Brakes: DSC, V-brake
Holes: 32, 36
Rim tape: 22mm
WIDTH: 19mm
VALVE: AV
SIZES: 24", 26", 27,5", 28/29"
COLORS: Black, Silver

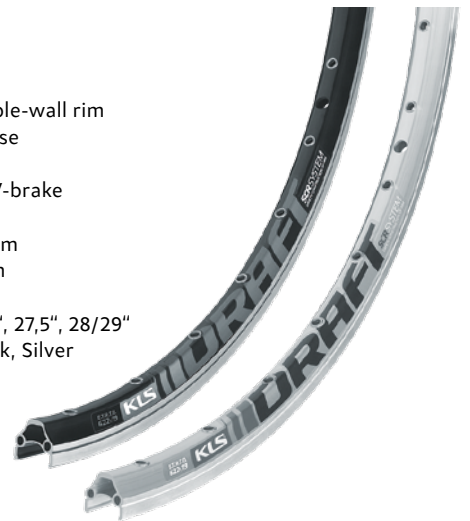

SPARK 017

RIM

Double-wall rim made especially for Road Racing
Single eyelet
Brakes: DSC, V-brake
Holes: 32
Rim tape: 18mm
WIDTH: 14,7mm
VALVE: FV
SIZES: 28"
COLORS: Black



SPARK 013

RIM

Double-wall rim made especially for Road Racing
Single eyelet
Brakes: DSC
Holes: 32
Rim tape: 18mm
WIDTH: 14,7mm
VALVE: FV
SIZES: 28"
COLORS: Black



SCART

RIM

Double-wall rim made for Urban E-bikes
Brakes: DSC
Holes: 32, 36
Rim tape: 22mm
WIDTH: 20mm
VALVE: FV
SIZES: 28"
COLORS: Black



WASPER

RIM

Single-wall rim made for kids sizes
Brakes: V-brake
Holes: 36(24"), 28(20"), 20(14")
Rim tape: 14mm
WIDTH: 19mm(24"), 21mm(20"), 20mm(14")
VALVE: AV
SIZES: 24", 20", 14"
COLORS: Silver

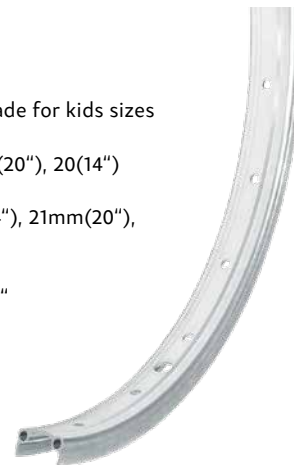



KLS wheels packaging box



DRAFT DSC FRONT

WHEEL

Rim: KLS Draft, double wall, single eyelet, 32 h
Hub: KLS Firework Disc, 6 bolt system, with QR
Spokes: 32 steel spokes
SIZES: 26", 27,5", 28/29"
COLOR: Black

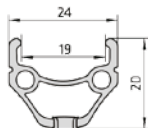

DRAFT DSC REAR

WHEEL

Rim: KLS Draft, double wall, single eyelet, 32 h
Hub: KLS Firework Disc, 8-10 speed, 6 bolt system, with QR
Spokes: 32 steel spokes
SIZES: 26", 27,5", 28/29"
COLOR: Black

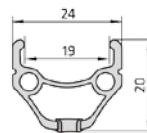

DRAFT FRONT

WHEEL

Rim: KLS Draft, double wall, single eyelet, 32 h
Hub: KLS alloy hub with QR system
Spokes: 32 steel spokes
SIZES: 26", 27,5", 28/29"
COLOR: Silver, Black

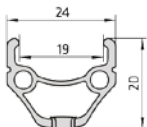

DRAFT REAR

WHEEL

Rim: KLS Draft, double wall, single eyelet, 32 h
Hub: KT-Ayer, 8-10 speed with QR system
Spokes: 32 steel spokes
SIZES: 26", 27,5", 28/29"
COLOR: Silver, Black

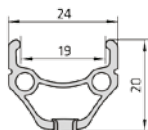

EVENT FRONT

WHEEL

Rim: KLS Event, single wall, 36 h
 Hub: KLS, nut type
 Spokes: 36 steel spokes
SIZE: 26", 28"
COLOR: Silver

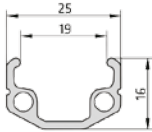

EVENT REAR

WHEEL

Rim: KLS Event, single wall, 36 h
 Hub: KLS, 7-speed, nut type
 Spokes: 36 steel spokes
SIZE: 26", 28"
COLOR: Silver

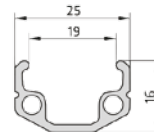

BOTTOM BRACKET CARTRIDGE

Sealed ball bearings
 Phosphate coated cold-forged steel cups
 Aluminum body
 Spindle screws included (pair)
 Thread BSA: BC1.37"x24T R/L 68mm
 Compatible with Shimano tools
 Spindle Lengths: 110, 113, 115, 117.5, 119, 122.5, 124.5, 127.5mm



SHS-30

SEMI-INTEGRATED HEADSET

Semi-integrated headset 1 1/8"
 Made of steel
 Bearings in cage 5/32"x20
DIAMETER: 28,6 / 44,0 / 30,0 mm
STACK HEIGHT: 22 mm
WEIGHT: 140g
COLOR: Black



THS-10

THREADED HEADSET

Threaded headset 1 1/8"
 Made of steel
 Bearings in cage 5/32"x20
DIAMETER: 25,4 / 34,0 / 30,0
WEIGHT: 169g
COLOR: Black

ITS-40

INTEGRATED HEADSET

Integrated tapered headset 1 1/8 - 1 1/2"
 Made of aluminium
 Sealed bearings 45° x 45°
 Including 2 race crowns 1 1/8" + 1 1/2",
 star nut, top cap and screw
DIAMETER: 28,6 / 41,8 / 52,0 / 30 - 39,8 mm
STACK HEIGHT: 10,5+0,7=11,2 mm
WEIGHT: 105g
COLOR: Black



AHS-20

A-HEAD HEADSET

Threadless headset 1 1/8" (A-head)
 Made of steel
 Bearings in cage 5/32"x20
DIAMETER: 28,6 / 34,0 / 30,0 mm
STACK HEIGHT: 22,7 mm
WEIGHT: 135g
COLOR: Black





SIZE CHARTS

CASUAL / BIKE WEAR

HEIGHT:

Measure from the top of the head to the floor while standing upright.

CHEST:

Measure around your chest, with arms relaxed down at sides. Measure around the fullest part of your chest, make sure the measuring tape will go around your shoulder blades. Keep the tape parallel to the floor.

WAIST:

Measure around natural waistline, keeping the tape a bit loose.

HIPS:

Measure with your feet together, keep tape straight and measure around the widest part of your hips.

INSEAM:

Measure inside of leg from the crotch to the ankle bone.

CASUAL WEAR:

MEN'S SIZES:	S	M	L	XL	XXL
HEIGHT:	165-175	168-178	171-181	174-184	179-189
CHEST:	88	94	100	106	112
WAIST:	78	84	90	96	102
HIPS:	91	97	103	109	115

WOMEN'S SIZES:	XS	S	M	L	XL
HEIGHT:	159-169	162-172	165-175	168-178	171-181
CHEST:	82	88	94	100	106
WAIST:	64	70	76	82	88
HIPS:	90	96	102	108	114

BIKE WEAR:

MEN'S SIZES:	S	M	L	XL	XXL
HEIGHT:	165-170	170-175	175-180	180-185	185-190
CHEST:	88-92	92-96	96-100	100-106	106-112
WAIST:	75-80	80-84	84-88	88-94	94-100
INSEAM:	81	82	83	84	85

WOMEN'S SIZES:	S	M	L	XL	XXL
HEIGHT:	160-164	164-168	168-172	172-176	176-180
CHEST:	85-90	90-94	94-100	100-106	106-112
WAIST:	68-72	72-76	76-80	80-86	86-92
INSEAM:	75,5	77	78,5	78,5	80

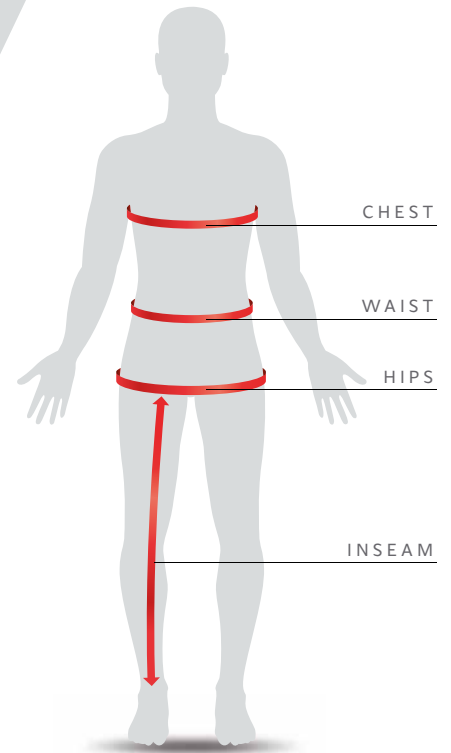

GLOVES

PALM CIRCUMFERENCE:

Measure around your hand with a tape measure across your palm. You should use your dominant hand, the right if you are right-handed, and the left if you are left-handed.

HAND LENGTH:

To determine hand length measure from the tip of your longest finger to the base of your palm at the wrist.

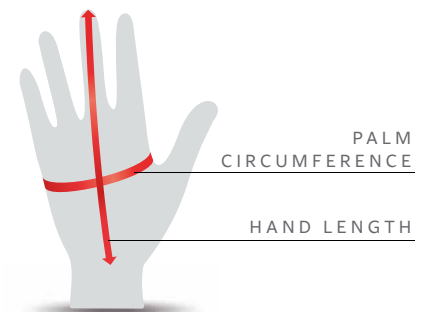

GLOVES SIZE:	XS	S	M	L	XL	XXL
PALM CIRCUMFERENCE:	17,8 cm	19,1 cm	20,3 cm	21,6 cm	24 cm	26,7 cm
HAND LENGTH:	15,7 cm	17 cm	18,3 cm	19,7 cm	21,1 cm	22,5 cm

CONTACTS

AUSTRALIA

Ride Sports ANZ Pty Ltd
East Building 6,
605 Zillmere Road
4034 Aspley, Queensland
Tel.: +61 1800 888 898
e-mail: info@ridesports.com.au

AUSTRIA

KELLYS BICYCLES s.r.o.
SLNECNA CESTA 374
922 01 VELKE ORVISTE
tel.: +421 333 213 140
fax: +421 333 213 199
e-mail: vladimir.skarka@kellysbike.com

BAHRAIN

Sabeel Trading S.P.C
Shop No 2209, Road 90, Block 1014
1014 Hamala
Phone Number: +973 17 612 995
e-mail: Sabeelbikeshop@gmail.com

BELARUS

VeloDrive
Papernyansky village council, N9037, 15/3
220030 Minsk
Tel.: +375 29 683 39 33
e-mail: bonviko@mail.ru

BULGARIA

VELOZONA LTD
25 OTEC PAISIY STREET
5100 GORNA ORQHOVITSA
tel.: +359 887 800 104
e-mail: velozona@abv.bg

CROATIA

L. K. D. D.O.O. KUTINA
A.G. MATOSA 12
KUTINA
tel. / fax: +385 (0)44 683 504
e-mail: mbjelajac@inet.hr
www.bikeshop.hr

CYPRUS

TASOS ALETRAS Ltd.
266 Tseriou Avenue
2044 NICOSIA STROVOLOS
tel.: +35 722 321015
fax: +35 722 321731
e-mail: info@aletras-megabike.com
www.aletras-megabike.com

CZECH REPUBLIC

KELLYS BICYCLES CZECH REPUBLIC s.r.o.
HAVLÍČKOVA 426
753 01 HRANICE
tel.: +420 581 698 810
e-mail: infocz@kellysbike.com

ESTONIA

VELOPLUS
SAKU 3
11314 TALLINN
tel.: +372 6 556 977
fax: +372 6 556 308
e-mail: veloplus@veloplus.ee
www.veloplus.ee

FINLAND

Kuopion pyöräkauppa bikemania oy
Puijonkatu 28
70100 KUOPIO
Tel.: +358 442 303 867
e-mail: posti@bikemania.fi

FRANCE

FREE SPORT SPIRIT
33 rue Brechenmacher
68380, Breitenbach
Tel.: +33 695 853 578
e-mail: contact-kellysbike@orange.fr

GEORGIA

LTD Freeriders
Shatberashvili street #2 Apartment #55
0179 Tbilisi
Tel.: +995 574 944 555
e-mail: info@freeriders@gmail.com

GERMANY

KELLYS BICYCLES DEUTSCHLAND
AM WALDBERG 15
12683 BERLIN
tel.: +49 (0)30 510 61 837
fax: +49 (0)30 510 61 838
e-mail: kellysdeutschland@kellysbike.com

HUNGARY

KELLYS BICYCLES s.r.o.
1051 Budapest,
Arany Janos u. 15.
tel: +36 20 351 7141
e-mail: Infohu@kellysbike.com

ITALY

MODOLO ITALIA SRLS
VIA VENZA 17
21028 VAZZOLA TV
tel.: +39 327 566 3036
tel.: +39 348 778 2801
e-mail: serena@modolo.com
e-mail: pietro.caschera@gmail.com

IRELAND

A.B. CYCLE FACTORS Ltd.
14A SOUTH SUMMER STREET
DUBLIN 8
tel.: +353 1 4532777
fax: +353 1 4544793
email: abcycles@eircom.net

ISRAEL

BILUBKES
Bilu 16, Jerusalem, Israel
Phone number : +972-2-5619494
Email: bilu.kellys@gmail.com

LATVIA

SIA AQUA PRO
GAROZES 1
LV-1004 RIGA
tel.: +371 762 6025
fax: +371 789 2053
e-mail: jurism@fans.lv

LITHUANIA

UAB MyBike
Draugystes 17
LT-51229, Kaunas
tel./fax: +370 3735 00 95
e-mail: aistis@mybike.lt

NORWAY

TEMPO AS
TORVLIA 14
1739 BORGENHAUGEN
tel: +47 69 100 570
fax: +47 69 166 252
e-mail: john@tempoas.no
www.tempoas.no

POLAND

KELLYS Sp. z o.o.
UL. E. KWIATKOWSKIEGO 24
55-011 SIECHNICE K. WROCŁAWIA
tel.: +48 71 318 88 77
fax: +48 71 318 88 99
e-mail: infopl@kellysbike.com

PORTUGAL

ALEXANDRE DIAS LDa
AV. VILLAGARCIA DE AROSA, 1060
4450-300 MATOSINHOS
tel.: +351 229 398 990
fax: +351 229 398 993
e-mail: alex.dias@mail.telepac.pt
www.alexandredias.net

RUSSIA

VELOOLIMP
MOSCOW, UL. ELEKTRODNAYA, DOM 2
tel./fax: +7 (495) 788 19 52
e-mail: mail@veloolimp.ru
www.kellys-russia.ru

SERBIA

IVA D.O.O.
TOLSTOJEVA 14
210 00 NOVI SAD
tel.: +381 215 422 16
e-mail: iva@iva.co.rs
www.iva.co.rs

SEYCHELLES

Maria Store,
La passe, La Digue,
Seychelles.
Tel.: +2482546196
e-mail: maria94@seychelles.net

SLOVAKIA

KELLYS BICYCLES s.r.o.
SLNEČNÁ CESTA 374
922 01 VELKÉ ORVIŠTE
tel.: +421 333 213 111
fax: +421 333 213 199
e-mail: infosk@kellysbike.com

SLOVENIA

PE BIKE CENTER
ERJAVCEVA ULICA 5
SI-2000 MARIBOR
tel.: +386 242 018 36
e-mail: info@bike-center.si
www.bike-center.si

SWEDEN

JAMTLANDS CYKELFABRIK
KYRGATAN 27
S-83131 ÖSTERSUND
tel./fax: +46 63 12 72 22
e-mail: info@jamtlands-cykelfabrik.se

SWITZERLAND

Loup Cycling SA
Rue du Vion 2
1587 Montmagny
Tel.: +41 266 772 226
e-mail: loup@loup-cycling.ch

TAIWAN

UNI-VICTOR INT'L CORP.
NO. 1, RENHUAGONG 10th RD., DALI DIST.,
TAICHUNG 41278
TAIWAN
tel.: +886 4 249 16 008
fax: +886 4 249 16 007
e-mail: infotw@kellysbike.com

U.A.E

Sabeel Trading S.P.C
Shop No 2209, Road 90, Block 1014
1014 Hamala, Bahrain
Phone Number: +971 56 706 8180
Email: Sabeelbikeshop@gmail.com

UKRAINE

VELOPORTAL LLC
6-A, HETMANA STR.
03057 KIEV
tel./fax: +380 44 331 9050
e-mail: admin@kellys.com.ua
www.kellys.com.ua



COMMUNITY

JOIN
US



[INSTAGRAM.COM/KELLYSBIKES](https://www.instagram.com/kellysbikes)



[FACEBOOK.COM/KELLYSBICYCLES](https://www.facebook.com/kellysbicycles)



[YOUTUBE.COM/USER/KELLYSBICYCLES](https://www.youtube.com/user/kellysbicycles)



[KELLYSBIKE.COM](https://www.kellysbike.com)



**EVERY BIKE
HAS A MISSION**

KELLYSBIKE.COM

©KELLYS BICYCLES. All rights reserved. KELLYS and KELLYS BICYCLES are protected trademarks of Kellys group.